

RGASKETX202 -325 to 1100°F (-198 to 593°C)
RGASKETX352 -100 to 450°F (-73 to 232°C) for standard service; to 300°F (149°C) for temperature cycling service

For necessary information concerning the installation of this gasket kit, please consult the appropriate Fisher product instruction manual.

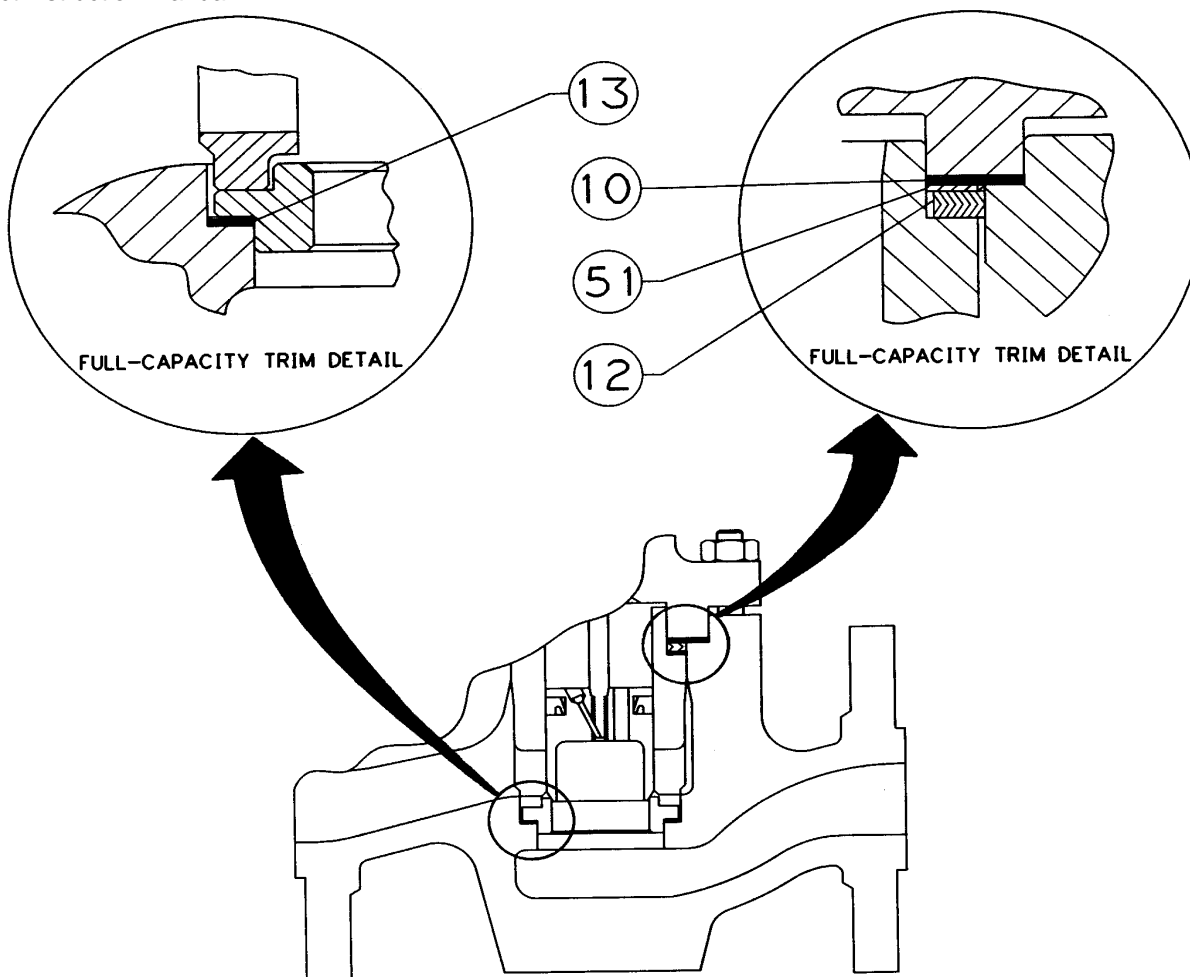

Key No.	Part Name	Outside Diameter
10	Bonnet Gasket	5.16 Inches
12	Spiral Gasket	4.62 Inches
13	Seat Ring Gasket	4.47 Inches
51	Shim	4.66 Inches

Gasket Sizing Key

©Fisher Controls International, Inc. 2000; All Rights Reserved
 Fisher and Fisher-Rosemount are marks owned by Fisher Controls International, Inc. or Fisher-Rosemount Systems, Inc.

The contents of this publication are presented for informational purposes only, and while every effort has been made to ensure their accuracy, they are not to be construed as warranties or guarantees, express or implied, regarding the products or services described herein or their use or applicability. We reserve the right to modify or improve the designs or specifications of such products at any time without notice.

For information, contact Fisher Controls:
 Marshalltown, Iowa 50158 USA
 Cernay 68700 France
 Sao Paulo 05424 Brazil
 Singapore 128461

