

Part Number D301150X412

May 2024

# FloBoss™ S600+ Flow Computer Instruction Manual



## Device Safety Considerations

### ▪ Reading these Instructions

Before operating the device, read these instructions carefully and understand their safety implications. In some situations, improperly using this device may result in damage or injury. Keep this manual in a convenient location for future reference. Note that these instructions may not cover all details or variations in equipment or cover every possible situation regarding installation, operation, or maintenance. Should problems arise that are not covered sufficiently in the text, immediately contact Customer Support for further information.

### ▪ Protecting Operating Processes

A failure of this device – for whatever reason -- may leave an operating process without appropriate protection and could result in possible damage to property or injury to persons. To protect against this, you should review the need for additional backup equipment or provide alternate means of protection (such as alarm devices, output limiting, fail-safe valves, relief valves, emergency shutoffs, emergency switches, etc.). Contact Remote Automation Solutions for additional information.

### ▪ Returning Equipment

If you need to return any equipment to Remote Automation Solutions, it is your responsibility to ensure that the equipment has been cleaned to safe levels, as defined and/or determined by applicable federal, state and/or local law regulations or codes. You also agree to indemnify Remote Automation Solutions and hold Remote Automation Solutions harmless from any liability or damage which Remote Automation Solutions may incur or suffer due to your failure to ensure device cleanliness.

### ▪ Grounding Equipment

Ground metal enclosures and exposed metal parts of electrical instruments in accordance with OSHA rules and regulations as specified in *Design Safety Standards for Electrical Systems*, 29 CFR, Part 1910, Subpart S, dated: April 16, 1981 (OSHA rulings are in agreement with the National Electrical Code). You must also ground mechanical or pneumatic instruments that include electrically operated devices such as lights, switches, relays, alarms, or chart drives.

**Important:** Complying with the codes and regulations of authorities having jurisdiction is essential to ensuring personnel safety. The guidelines and recommendations in this manual are intended to meet or exceed applicable codes and regulations. If differences occur between this manual and the codes and regulations of authorities having jurisdiction, those codes and regulations must take precedence.

### ▪ Protecting from Electrostatic Discharge (ESD)

This device contains sensitive electronic components which be damaged by exposure to an ESD voltage. Depending on the magnitude and duration of the ESD, it can result in erratic operation or complete failure of the equipment. Ensure that you correctly care for and handle ESD-sensitive components.

## System Training

A well-trained workforce is critical to the success of your operation. Knowing how to correctly install, configure, program, calibrate, and trouble-shoot your Emerson equipment provides your engineers and technicians with the skills and confidence to optimize your investment. Energy and Transportation Solutions offers a variety of ways for your personnel to acquire essential system expertise. Our full-time professional instructors can conduct classroom training at several of our corporate offices, at your site, or even at your regional Emerson office. You can also receive the same quality training via our live, interactive Emerson Virtual Classroom and save on travel costs. For our complete schedule and further information, contact the Energy and Transportation Solutions Training Department at 800-338-8158 or email us at [education@emerson.com](mailto:education@emerson.com).

## Ethernet Connectivity

This automation device is intended to be used in an Ethernet network which **does not** have public access. The inclusion of this device in a publicly accessible Ethernet-based network is **not recommended**.

# Contents

<b>Chapter 1 – General Information</b>	<b>1-1</b>
1.1 Scope of Manual .....	1-1
1.2 FloBoss S600+ Flow Computer .....	1-2
1.3 Config600 Configuration Software .....	1-5
1.3.1 Config600 Lite .....	1-6
1.3.2 Config600 Lite Plus .....	1-7
1.3.3 Config600 Pro .....	1-7
1.4 Additional Technical Information .....	1-8
1.4.1 Open Source Software .....	1-8
<b>Chapter 2 – Installation</b>	<b>2-1</b>
2.1 Preparing for Installation .....	2-1
2.2 Environmental Considerations .....	2-2
2.3 Required Tools for Installation .....	2-2
2.4 Installing the S600+ .....	2-3
2.4.1 Unpacking the S600+ .....	2-3
2.4.2 Removing the Front Panel .....	2-3
2.4.3 Installing the Panel-Mounted Unit .....	2-6
2.4.4 Reinstalling the Front Panel .....	2-8
2.5 Installing and Removing Modules .....	2-8
2.6 Installing EMC Protection .....	2-10
<b>Chapter 3 – CPU Module</b>	<b>3-1</b>
3.1 CPU Module (P152) .....	3-1
3.2 Power Supply .....	3-4
3.2.1 Watchdog Relay .....	3-4
3.2.2 On-Board Battery Backup .....	3-4
3.3 Communication Ports .....	3-5
3.3.1 RS-232 Serial Port .....	3-6
3.3.2 RS-422/RS-485 Multi-drop Port .....	3-7
3.3.3 Ethernet LAN Ports .....	3-7
3.3.4 Local Operator PC or Remote Display Port .....	3-8
3.4 CPU Connectors and Jumpers .....	3-9
3.5 USB Port .....	3-10
3.6 Additional Technical Information .....	3-10
<b>Chapter 4 – Input/Output (I/O)</b>	<b>4-1</b>
4.1 I/O Module (P144) .....	4-1
4.1.1 Analogue Inputs (ANIN) .....	4-3
4.1.2 Analogue Outputs (DAC) .....	4-5
4.1.3 Digital Inputs (DIGIN) .....	4-6
4.1.4 Digital Outputs (DIGOUT) .....	4-8
4.1.5 Turbine Pulse Inputs .....	4-9
4.1.6 Pulse Outputs (PULSEOUT) .....	4-10
4.1.7 Raw Pulse Output (RAWOUT) .....	4-11
4.1.8 Frequency Inputs .....	4-12
4.1.9 PRT/RTD Inputs .....	4-13
4.1.10 Jumper Settings .....	4-14
4.2 Prover Module (P154) .....	4-16
4.2.1 Digital Inputs (DIGIN) .....	4-19
4.2.2 Digital Outputs (DIGOUT) .....	4-20

4.2.3	Turbine Pulse Inputs .....	4-21
4.2.4	Pulse Outputs (PULSEOUT).....	4-22
4.2.5	Frequency Inputs .....	4-23
4.2.6	Raw Pulse Output (RAWOUT).....	4-24
4.2.7	Jumper Settings .....	4-24
4.3	HART Module (P188).....	4-25
4.4	Mezzanine Module (P148).....	4-28

---

## **Chapter 5 – Front Panel** **5-1**

---

5.1	Description .....	5-1
5.2	Front Panel Port.....	5-2
5.3	Keypad .....	5-2
5.3.1	Function Keys (F1 - F4) .....	5-2
5.3.2	Direction and Menu Keys.....	5-3
5.3.3	Numeric Keys.....	5-3
5.3.4	Operation Keys .....	5-3
5.3.5	Alarm LED and Alarm Keys .....	5-4
5.4	LCD Display .....	5-4
5.5	Navigating the Displays.....	5-6
5.5.1	DISP Key.....	5-8
5.5.2	Moving Through the Menus .....	5-8
5.5.3	Menu Hierarchy.....	5-9
5.5.4	Security Codes.....	5-9
5.6	Changing a Display Option .....	5-9
5.7	Changing a Display Value.....	5-10
5.8	Changing a Calculation Mode.....	5-11
5.9	Assigning a Default Page.....	5-12
5.10	Assigning a Page to a Function (F) Key .....	5-12
5.11	Using the Exponential (EXPT) Key .....	5-12
5.12	Using the Print Key .....	5-13
5.13	Enabling USB.....	5-14
5.14	Exporting Reports (USB).....	5-14
5.15	Selecting a Configuration .....	5-16

---

## **Chapter 6 – Webserver Access** **6-1**

---

6.1	Defining Webserver Access.....	6-1
6.2	Accessing the S600+ .....	6-2
6.3	Navigating the Webserver Interface.....	6-4

---

## **Chapter 7 – Startup** **7-1**

---

7.1	Starting the S600+ .....	7-1
7.2	Warm Start .....	7-1
7.3	Cold Start .....	7-2
7.3.1	Initiating a Cold Start.....	7-2
7.4	Startup Menu.....	7-3
7.4.1	Network Setup.....	7-4
7.5	Messages.....	7-7

---

## **Chapter 8 – Troubleshooting** **8-1**

---

8.1	Guidelines .....	8-1
8.2	Checklists.....	8-2
8.2.1	Power Issues.....	8-2
8.2.2	Startup Menu.....	8-2
8.2.3	Front Panel Lighting.....	8-2
8.2.4	Front Panel LED.....	8-2
8.2.5	I/O LED .....	8-3
8.2.6	I/O Fail Messages .....	8-3

---

8.2.7	Serial Communications .....	8-3
8.3	Procedures .....	8-3
8.3.1	Reflash Firmware .....	8-4
8.3.2	Send and Reflash the Config File .....	8-4
8.3.3	Clear SRAM .....	8-5
8.3.4	Changing the Fuse .....	8-6
<b>Appendix A – Glossary</b>		<b>A-1</b>
<b>Appendix B – Front Panel Navigation</b>		<b>B-1</b>
B.1	Main Menu.....	B-2
B.2	Flow Rates Menu .....	B-2
B.3	Totals Menu.....	B-3
B.4	Operator Menu .....	B-4
B.5	Plant I/O Menu .....	B-5
B.6	System Settings Menu .....	B-5
B.7	Tech/Engineer Menu.....	B-6
B.8	Calculations Menu.....	B-7
<b>Index</b>		<b>I-1</b>

---

*[This page is intentionally left blank.]*

# Chapter 1 – General Information

## In This Chapter

1.1	Scope of Manual.....	1-1
1.2	FloBoss S600+ Flow Computer.....	1-2
1.3	Config600 Configuration Software.....	1-5
1.3.1	Config600 Lite.....	1-6
1.3.2	Config600 Lite Plus.....	1-7
1.3.3	Config600 Pro.....	1-7
1.4	Additional Technical Information.....	1-8
1.4.1	Open Source Software.....	1-8

This manual covers the installation and startup procedures (including basic maintenance, operation, and troubleshooting) for the FloBoss™ S600+ flow computer (the “S600+”). For information about Config600™, the PC-based configuration software for the S600+, refer to the *Config600 Software User Manual* (Part D301220X412).

This manual focuses on the S600+, the enhanced version of the S600 with a new CPU module. Refer to technical specification *FloBoss S600+ Flow Computer* (S600+) for technical information.

**Note:** Use of this equipment in a manner not specified by Remote Automation Solutions may impair the protections the equipment provides.

This chapter details the structure of this manual and provides an overview of the S600+ and its components.

## 1.1 Scope of Manual

This manual contains the following chapters:

Chapter	Contents
Chapter 1 General Information	Provides an overview of the S600+ and its configuration software (Config 600).
Chapter 2 Installation	Provides instructions on installing the S600+ housing, as well as installation preparation and panel mounting procedures. This chapter also describes the installation and removal of the plug-in modules.
Chapter 3 CPU	Describes the use of the communications and power connector blocks, field wiring configurations, and jumper settings for the CPU module.
Chapter 4 Input/Output (I/O)	Describes the use of the plug-in connector blocks, field wiring configurations, and bit link settings for the I/O modules.

Chapter	Contents
Chapter 5 Front Panel	Describes the front panel keypad, communications port, and display area. This chapter also shows how you access the S600+ through the front panel display, including keypad functions, screen displays, display navigation basics, data entry, and report printing.
Chapter 6 Webserver Access	Provides instructions on accessing the S600+ through a webserver interface, including descriptions of screen displays and interface navigation basics.
Chapter 7 Startup	Describes how to initiate a warm or cold system start.
Chapter 8 Troubleshooting	Provides maintenance and troubleshooting procedures, including basic board-level test procedures.
Appendix A Glossary	Provides definitions for pertinent terms and acronyms.
Appendix B Front Panel Display Navigation	Lists the front panel display screens; provides a navigation reference.
Index	Provides an alphabetic listing of items and topics contained in this manual.

## 1.2 FloBoss S600+ Flow Computer



*Figure 1-1. The FloBoss S600+ Flow Computer*

The FloBoss S600+ Flow Computer is a panel-mounted (for indoor-use) flow computer designed specifically to measure hydrocarbon liquid and gas where versatility and accuracy matter. The standard features of the S600+ make it ideal for fiscal measurement, custody transfer, batch loading, and meter proving applications. The S600+ allows you to configure multi-stream, multi-station applications, enabling you to simultaneously meter liquids and gasses.

The S600+ is designed for use either as a stand-alone flow computer or as a system component. The intelligent I/O modules fit both gas and liquid applications and typically support two dual-pulsed streams and a



header. Adding I/O modules (up to a maximum of three) allows you to configure up to six dual-pulsed streams or up to 10 single-pulsed streams and two headers. The S600+ supports orifice, ultrasonic, turbine, positive displacement, Coriolis, Annubar, and V-Cone® flow meter types and master meter, small volume compact, and pipe (both bi-directional and uni-directional) proving methods.

The S600+ offers a variety of communication interfaces:

- Two LAN ports (on the enhanced CPU module) for Ethernet 10Base-T or 100Base-T full-duplex connectivity (using either Modbus TCP or Modbus over Ethernet protocols).

---

**Note:** The Ethernet module (P190), which provided an additional Ethernet port for previous versions of the S600, is **not** compatible with the S600+.

---

- HART® communication using up to two 12-channel HART modules, each of which supports point-to-point and multi-drop architectures for up to 50 transmitters.

---

**Note:** The FloBoss S600+ is fully compatible with HART 5 devices, and HART 7 devices are backwards compatible with HART 5 devices.

---

- An embedded webserver allows remote access to the flow computer. Security is provided using user name and password protection with a detailed event log for audit purposes (supports Microsoft® Edge™ or Windows® Internet Explorer® version 5 or greater [version 9 or greater must use compatibility mode]).
- Two configurable RS-232 serial ports.
- Three RS-422/RS-485 serial ports (supporting up to 57,600 bps baud) and up to four RS-485 2-wire serial ports (supporting up to 57,600 baud rate) for connection to intelligent meters, Modbus SCADA data networks, DCS supervisory systems, and so on.
- One dedicated configuration port (located on the bottom of front display panel) for connection to the Config 600 configuration software.
- Additional communications interfaces include:
  - Serial Q.Sonic®
  - Serial printer
  - Serial or Modbus TCP Daniel chromatograph via Modbus
  - Serial peer-to-peer
  - Modbus EFM protocol, Modbus RTU, Modbus ASCII, Modbus over Ethernet, and Modbus TCP
- Miscellaneous interfaces which can operate via serial or Modbus TCP:
  - Daniel liquid ultrasonic
  - Daniel gas ultrasonic

- Sick ultrasonic
- Daniel chromatograph

---

**Note:** All ports can connect to DCS systems, ultrasonic meters, Coriolis meters, and so on.

---

The S600+ uses distributed processing to achieve maximum performance. The CPU module incorporates a hardware floating point processor. Each additional module also has local processing to convert inputs and output from engineering units to field values and vice-versa, as well as running background tests and PID loops.

The firmware uses 64-bit (double) precision floating point numbers for the highest accuracy when performing all metering calculations. Cumulative totals are stored in three separate memory locations (Tri-reg format) for maximum integrity. The user language LogiCalc™ also allows you to perform logical control and double-precision mathematical functions on the database objects.



*Figure 1-2. CPU Module*

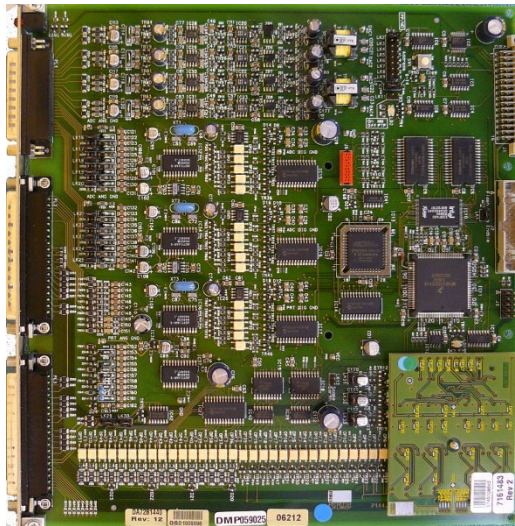

Figure 1-3. Intelligent I/O Module

### Front Display Panel

The S600+'s front panel interface enables you to manage an existing configuration or create a configuration using the PC-based Config 600 configuration software.

A communications port on the bottom of the panel provides a way to directly connect to a PC. The front panel interface consists of a backlit LCD display, a 29-button keypad, and an alarm status LED (see *Figure 1-4*).



Figure 1-4. Front Display Panel

## 1.3 Config600 Configuration Software

Using Config 600, you can both send (upload) new or modified configurations to the S600+ and receive (download) existing

configurations from the S600+. You can also define the following functions:

- Stream and station totalisation.
- Batch totalisation and correction.
- Three-term PID control.
- Flow balancing.
- Flow scheduling.
- Automatic proving sequence.
- K-factor or meter factor linearisation.
- Valve monitor/control.
- Sampler control.
- Station densitometer.
- Station gas chromatograph.
- Forward, reverse, and premium error totals.
- Comprehensive maintenance mode.
- Reporting.
- Modbus.
- Modify display matrix.

Config600 is a suite of software editors that enables you to monitor, configure, and calibrate the S600+. The software comes in three versions – Config600 Lite, Config600 Lite Plus, and Config600 Pro – with Config600 Pro being the most powerful version.

---

**Note:** The S600+ does not operate until you send a configuration to it from the host PC.

---

**IPL600** Remote Automation Solutions provides a separate utility program called “Interactive Program Loader 600” (or “IPL600”).

Using IPL600 and an IP or a dedicated serial port connection between a host PC and an S600+, you can transfer and receive configuration files (reports, Modbus configurations, customised displays, and LogiCalc programs). While included as the Config Transfer utility in Config600, IPL600 has a standalone use for situations when you do not need the full functionality of Config600. Details on using Config Transfer/IPL600 are provided in the *Config600 Software User Manual* (Part D301220X412).

### 1.3.1 Config600 Lite

Use the Config 600 Lite software editor suite to modify pre-developed configurations, transfer existing configurations, edit items on the front panel display, and customise reports.

---

**Note:** You typically use Config600 Lite to custom-configure a new S600+ during installation.

---

With Config600 Lite you can:

- Edit process configuration data, including orifice size, analog input scaling, alarm limits, and keypad values.
- Build and customise Modbus slave maps, Modbus master polling sequences, front panel displays, and period report formats.
- Customise the alarm system, including alarm groups, suppression, and inhibits.
- Configure system security by setting user names and passwords, and assigning access levels for each data object on the displays.
- Specify the engineering units and totalisation rollover value.
- Reflash the CPU module firmware with software upgrades and transfer configurations via the Config Transfer utility (IPL600).

### 1.3.2 Config600 Lite Plus

The Config600 Lite Plus software editor suite provides all the functionality of the Config600 Lite suite, but adds the ability to create a configuration file.

With Config600 Lite Plus you can:

- Create a new application from base templates for gas, liquid, and prover applications.
- Edit process configuration data, including orifice size, analog input scaling, alarm limits, and keypad values.
- Build and customise Modbus slave maps, Modbus master polling sequences, front panel displays, and period report formats.
- Customise the alarm system, including alarm groups, suppression, and inhibits.
- Configure system security by setting user names and passwords, and assigning access levels for each data object on the displays.
- Specify the engineering units and totalisation rollover value.
- Reflash the CPU module firmware with software upgrades and transfer configurations via the Config Transfer utility (IPL600).

### 1.3.3 Config600 Pro

Use the Config600 Pro software editor suite to create new configurations, modify existing configurations, transfer existing configurations, edit items on the front panel display, and edit custom reports.

With Config600 Pro you can:

- Create a new application from base templates for gas, liquid, and prover applications.
- Edit process configuration data, including orifice size, analog input scaling, alarm limits, and keypad values.
- Build and customise Modbus slave maps, Modbus master polling sequences, front panel displays, and period report formats.
- Specify the engineering units and totalisation rollover value.

- Customise the alarm system, including alarm groups, suppression, text, and inhibits.
- Configure system security by setting user names and passwords, and assigning access levels for each data object.
- Add and remove objects from the database.
- Program special features using LogiCalc.
- Reflash the CPU module firmware with software upgrades and transfer configurations via the Config Transfer utility (IPL600).

---

**Note:** To obtain a Config600 Pro license you must first attend and successfully complete a training course.

---

## 1.4 Additional Technical Information

---

Refer to the following technical documents (available at [www.Emerson.com/EnergyandTransportation](http://www.Emerson.com/EnergyandTransportation)) for additional and most-current information.

*Table 1-1. Related Technical Information*

Name	Form Number	Part Number
FloBoss™ S600+ Flow Computer	S600+	D301151X412
Config600™ Configuration Software	Config600	D301164X012
Config600™ Configuration Software User Manual	A6169	D301220X412

### 1.4.1 Open Source Software

The FloBoss S600+ contains open source software covered by the GPL, GPL2, GPL3, LGPL, OpenSSL, SSLeay, zlib, libzip2, and Apache open source software licenses. The specific software being used is U-Boot, the Linux kernel, glibc, Apache web server, mod\_ssl, mod\_alias, mod\_rewrite, OpenSSL, BusyBox, ntpclient, tar32, and JFFS2. These licenses are contained on the S600+ Open Source Software CD (part number S600SRCOPEN). Source code is available upon request. You may obtain a copy of this source code by contacting your local Remote Automation Solutions sales office. This product includes software developed by the OpenSSL Project for use in the OpenSSL Toolkit (<http://www.openssl.org>). This product includes cryptographic software written by Eric Young ([ey@cryptsoft.com](mailto:ey@cryptsoft.com)).

## Chapter 2 – Installation

### In This Chapter

2.1	Preparing for Installation.....	2-1
2.2	Environmental Considerations.....	2-2
2.3	Required Tools for Installation.....	2-2
2.4	Installing the S600+ .....	2-3
2.4.1	Unpacking the S600+.....	2-3
2.4.2	Removing the Front Panel .....	2-3
2.4.3	Installing the Panel-Mounted Unit.....	2-6
2.4.4	Reinstalling the Front Panel.....	2-8
2.5	Installing and Removing Modules.....	2-8
2.6	Installing EMC Protection .....	2-10

This chapter provides instructions on installing the S600+, including installation preparation, procedures for panel-mounting, the installation and removal of plug-in modules, and electromagnetic compatibility (EMC) considerations.

---

 **Caution** Failure to exercise proper electrostatic discharge precautions (such as wearing a grounded wrist strap) when accessing the back of the unit or when handling CPU or I/O modules may reset the processor or damage electronic components, resulting in interrupted operations.

---

### 2.1 Preparing for Installation

The S600+ installation must conform to all applicable local codes and regulations. All installation procedures should be in accordance with normal practices of good workmanship. Although the S600+ shipped to you may not include all of the hardware options described in this manual, the procedure for the basic installation of the unit remains the same.

**Note:** We strongly recommend you familiarize yourself with the procedures described in this chapter **before** you begin to install the S600+.

The S600+ uses a modular design that provides maximum flexibility and ease of installation. The basic panel-mounted version consists of three major components:

- Fabricated metal case, complete with pre-installed PSU/backplane and four card slots for the modules (a dedicated CPU slot and three I/O slots).
- Removable front panel comprising the LCD display and keypad assembly.
- Plug-in modules. A CPU module and one I/O module are supplied for a basic configuration; two blank plates are supplied to cover the unused slots.

*Figure 2-1* shows the S600+ system components.



Figure 2-1. FloBoss S600+ System Components

---

**Note:** User-supplied tools to assist in the installation process may include a Phillips screwdriver, a regular screwdriver, a small adjustable spanner wrench, and a 2.5mm Allen key.

---

## 2.2 Environmental Considerations

---

The S600+ panel mounted flow computer is designed for use within the control room. Place it in a position that provides ease of use, comfort, and safety for operators and maintenance personnel. The optimum height for viewing and using the display and keypad is at operator eye level.

---

**! Caution**

If you install one or more units in a confined space with other heat-producing equipment, give special attention to the combined heating effect. This combined heat could increase the environmental temperature beyond its acceptable threshold, thereby impacting performance.

---

## 2.3 Required Tools for Installation

---

Before you attempt to install the S600+, ensure that you have the following tools:

- Small flat-blade screwdriver suitable for the slot-headed captive screws on the rear of the case that secure each plug-in board into the case.
- 5.5 mm (5 BA) hex or small adjustable wrench for the front panel bosses.



- 2.5 mm Allen key suitable for the hex cap screw on the front face of the front panel that secures the front panel molding to the case.

## 2.4 Installing the S600+

Refer to the following procedures for installing the various S600+ components, including the front panel, panel-mounted unit, and modules.

### 2.4.1 Unpacking the S600+

Unpack the S600+ carefully and inspect parts for visual damage.

**Note:** Do not discard packaging material until after you have identified all pieces of the shipment and you are confident that all parts are working correctly.

### 2.4.2 Removing the Front Panel

To begin the mounting process, remove the front panel from the S600+:

1. Ensure power has been removed from the S600+.
2. Using a 2.5 mm Allen key, remove the hex cap screw from the bottom centre of the front panel (refer to *Figure 2-2*).



*Figure 2-2. Removing the Front Panel*

**Note:** A security cap may cover the hex cap screw.

3. Carefully slide the front panel up 4 mm (0.15 in) to allow it to clear the retaining groove at the top of the case, and then allow the panel to come forward to clear the panel case completely (refer to *Figure 2-3*).

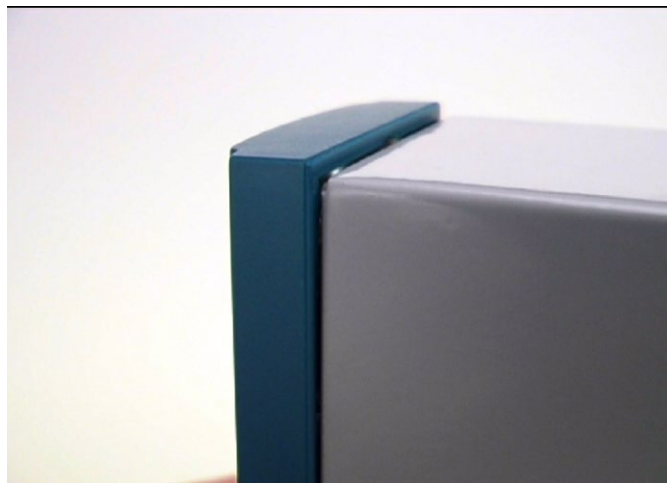

*Figure 2-3. Lifted Front Panel*

4. Disconnect the ribbon cable from the back of the front panel at the blue connector (refer to *Figure 2-4*). Observe the orientation of the connector with its mating keyway. You must correctly re-insert the ribbon cable at the end of the installation process.

---

**⚠ Caution**

**Do not remove the ribbon cable from the S600+ housing. This might damage the S600+. Also, the ribbon cable may also have an EMC clamp. Be sure to leave it intact without damaging the ribbon cable.**

---

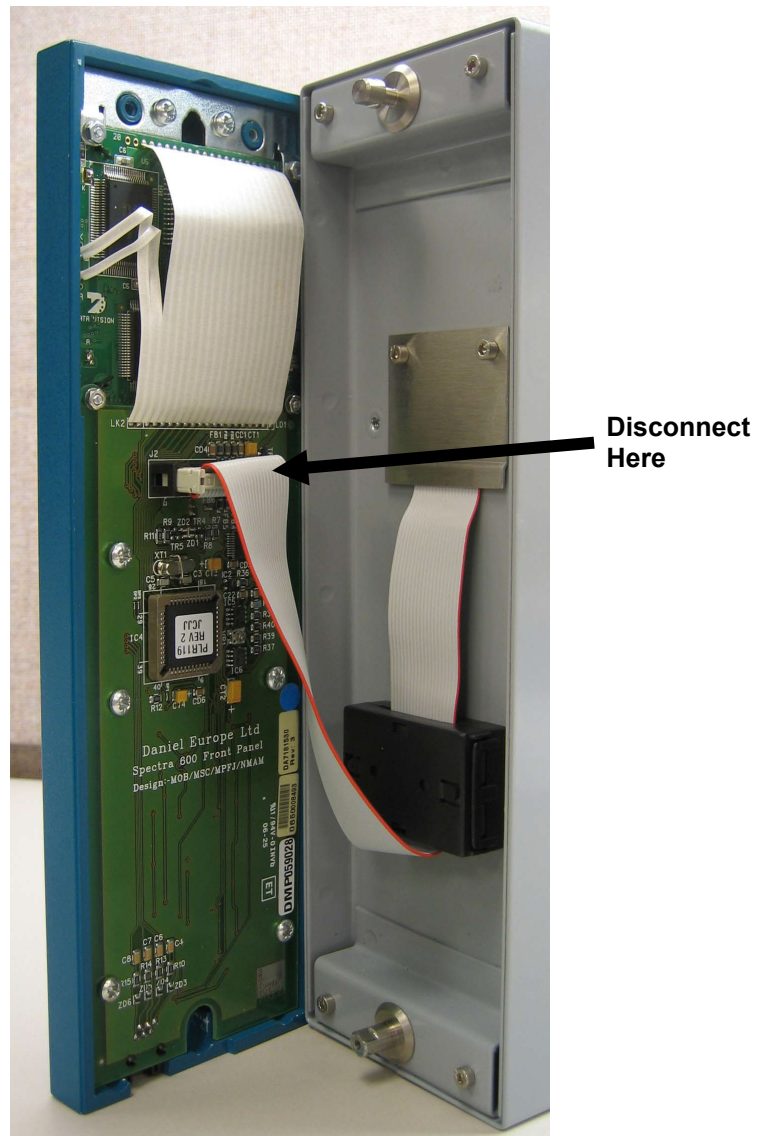

Figure 2-4. Remove Connector

- Remove the top and bottom bosses from the unit housing, using a 5.5 mm (5 BA) hex wrench.

Table 2-1. Mounting Dimensions

Part	Dimensions
Display Keypad Molding	85 mm (3.35") width x 269 mm (10.59") height x 28 mm (1.10") deep
Case	84.5 mm (3.327") width x 270 mm (10.63") height x 303.8 mm (11.94") deep
Panel Cutout	66 mm (2.6") width x 150 mm (5.9") height
Pitch Between Cases	110 mm (4.33") giving 25 mm (0.98") air gap
Max Panel Thickness	10 mm (0.39")
Access	Allow 300 mm (11.81") clearance directly behind case for maintenance

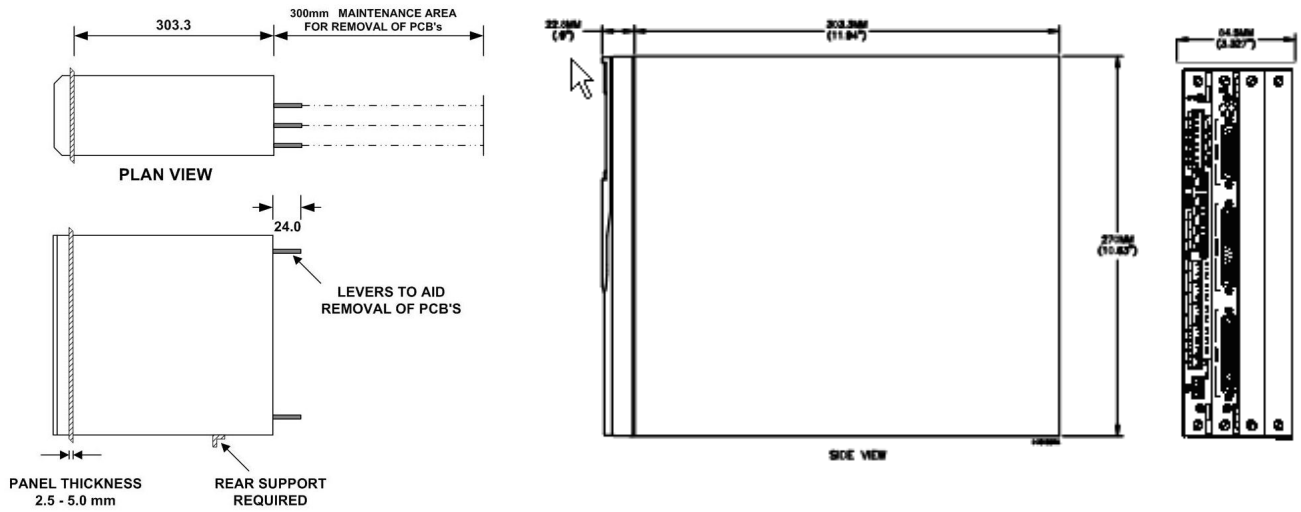

Figure 2-5. Panel Mount Dimensions

### 2.4.3 Installing the Panel-Mounted Unit

After removing the front panel, install the panel-mounted unit:

1. Keeping environmental considerations in mind, construct the framework of the cubicle to support the operating panel.

---

**Note:** A standard 483 mm (19 in) rack that is 311 mm (12.25 in) high can accommodate up to four S600+s provided you support the rear of the case.

---

2. Refer to *Figure 2-6* and *Table 2-1* for position details for two 7 mm (0.276 in) holes and a cutout. The panel cutout should be rectangular for each S600+. Allow a tolerance of  $\pm 3$  mm (0.12 in) on each axis.

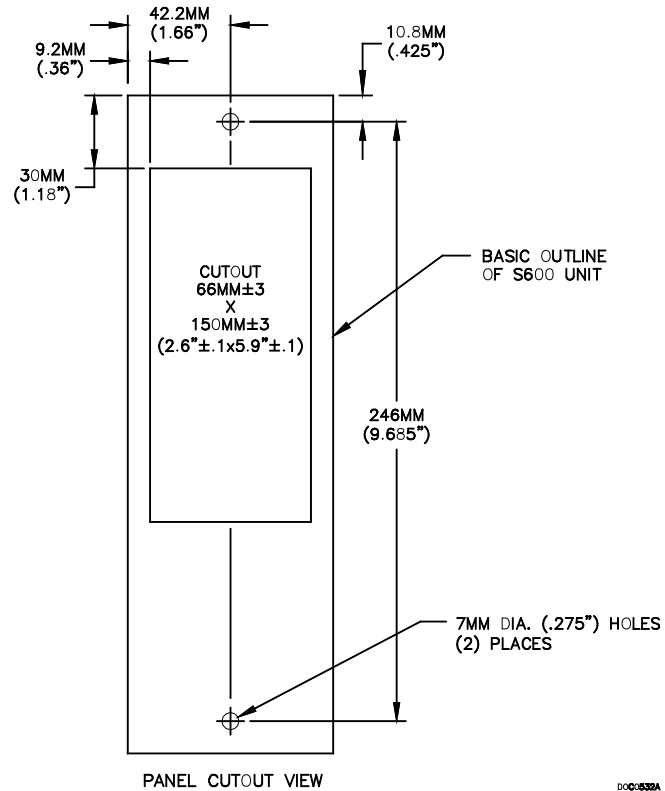

Figure 2-6. Panel Cutout Dimensions

**Note:** The S600+ fits into existing S500 and 869 flow computer panel cutouts.

3. Ensure a panel thickness of at least 3 mm (0.12 in) to prevent distortion. If you use a thinner panel, support the rear of the case (refer to *Figure 2-7*).



**Caution**

Always use a rear support or anchor to prevent twisting and other distortion effects during installation and maintenance.



Figure 2-7. Panel Mount Support

4. Place the front of the case against the rear of the prepared cutout.
5. Re-install the top and bottom bosses and tighten with a 5.5 mm (5 BA) hex wrench.
6. Once you have fitted the rear support, use a self-tapping screw to secure the case to the rear support. The maximum depth of the screw inside the case should be 3 mm (0.12 in).

#### 2.4.4 Reinstalling the Front Panel

Re-installing the front panel is the final stage of the installation process:

1. Connect the ribbon cable to the front panel.



**Caution**

**Note how the connector fits into the keyway. You must insert the ribbon cable correctly. Do not force the connector into the keyway.**

---

2. Place the top of the front panel over the retaining groove on the top boss and slide the front panel downwards.
3. Secure the front panel by placing the hex cap screw into its recess in the bottom centre of the front panel.
4. Using a 2.5 mm Allen key, tighten the screw finger-tight. Turn an additional 180 degrees clockwise to complete the installation.

---

**Note:** Replace the security cap if one was originally fitted.

---



**Caution**

**Do not over-tighten the screw. Over-tightening will damage the panel face.**

---

### 2.5 Installing and Removing Modules

---

The S600+ ships with the CPU and I/O modules already installed. Follow this procedure if you need to remove the modules for maintenance or upgrade purposes.

The CPU module is located at the left-most rear slot of the case. You can insert I/O modules in the remaining slots or leave them empty. Cover any empty slots with the blank cover plates.



**Caution**

**Take suitable electrostatic discharge precautions before you remove any of the modules.**

**The terminals on some modules may be wired to electrical potentials sufficiently high to cause electrical shock and injury. Turn off and discharge any power sources for connected devices before you perform any installation or repair work.**

---

**Removal** To remove a module:

1. Power down the S600+ before you attempt to extract a module.
2. Unscrew the retention screws before you attempt to remove a module. This avoids damage to the ejectors (refer to *Figure 2-8*).

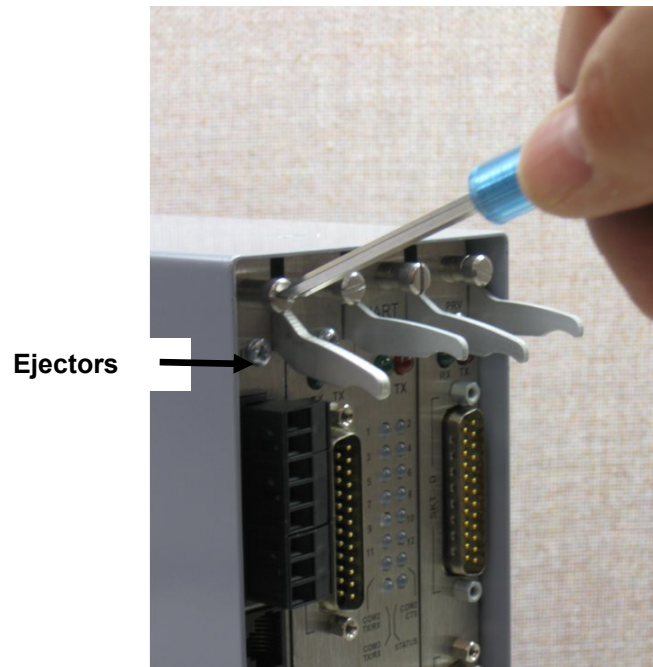

*Figure 2-8. Unscrewing the Retention Screws*

3. Unlatch the ejectors for the appropriate module and pull the module clear of the case. You may need to rock the module slightly to release it from its connectors (refer to *Figures 2-9* and *2-10*).



*Figure 2-9. Using the Ejectors*



Figure 2-10. Module Ready for Removal or Insertion

**Installation** To install a module:

1. Carefully align the module with the guides (located at the top and bottom of the case). Gently slide the module into the case until it seats fully with the appropriate connector on the backplane.
2. Press each of the two ejectors securely into place once the module is fully inserted.



**Caution**

**Inserting and seating a module along the guides does not require excessive force. Take care not to twist or otherwise distort the module during the installation.**

---

3. Secure the module with the retention screws (two per board).

## 2.6 Installing EMC Protection

---

Your site may require you to install electromagnetic compatibility (EMC) shielding on the S600+ to minimize electromagnetic interference. The S600+ EMC protection kit (which came with your S600+) typically has the following components:

- 1 security backplate (place over the installed modules)
- 1 25-way EMISTOP Inline T Filter Adaptor (attach to the 25-pin socket A on the I/O module)
- 1 37-way EMISTOP Inline T Filter Adaptor (attach to the 37-pin socket B on the I/O module)
- 3 large (for 13mm cable) ferrite clamps
- 3 medium (for 10mm cables) ferrite clamps
- 1 small (for 6.5mm cables) ferrite clamp





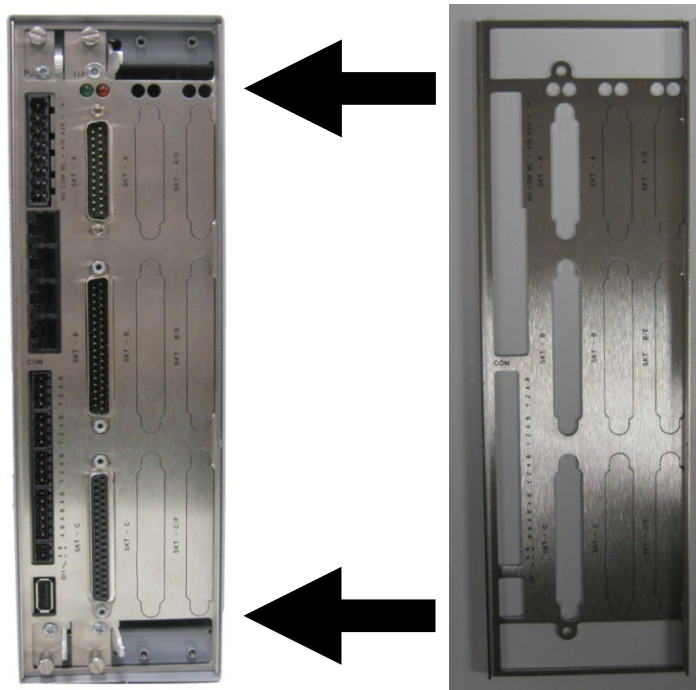

Figure 2-12. Security Backplate in Place

---

**Note:** In actual operation, the two right-most slots on the S600+ shown in *Figure 2-12* would either contain modules or would be covered by blanking plates.

---

3. Secure the backplate to the sides of the S600+ housing using the 2 M3 x 6mm screws.
4. Place and secure the 25-way and 37-way EMISTOP adaptors (see *Figure 2-13*) onto, respectively, sockets A and B on the I/O module (see *Figure 2-14*).



Figure 2-13. EMISTOP Connector

5. Wire the modules according to your site's requirements.
6. Attach a small ferrite clamp onto the wiring to socket A on the I/O module. Attach large ferrite clamps onto the cables to sockets B and C (see *Figure 2-14*).

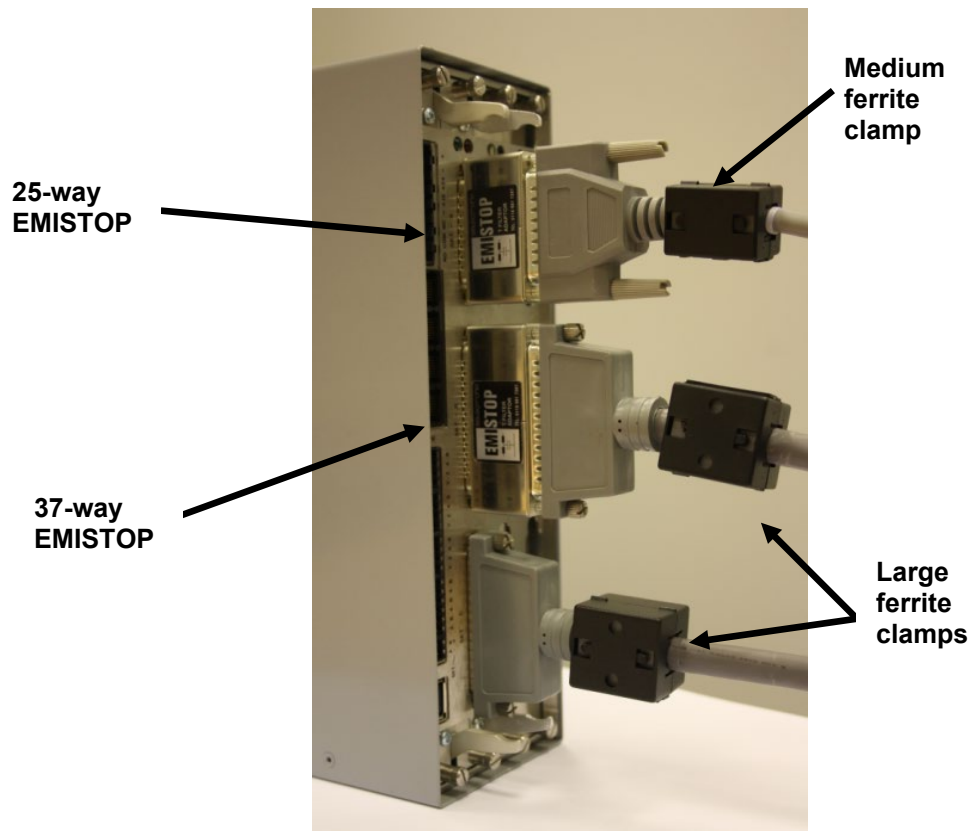

Figure 2-14. Clamps on I/O Module Wiring

7. Attach a large ferrite clamp onto the wiring to the CPU's power connections and one medium clamp to the COM3 and COM 4 connections (see Figure 2-15).

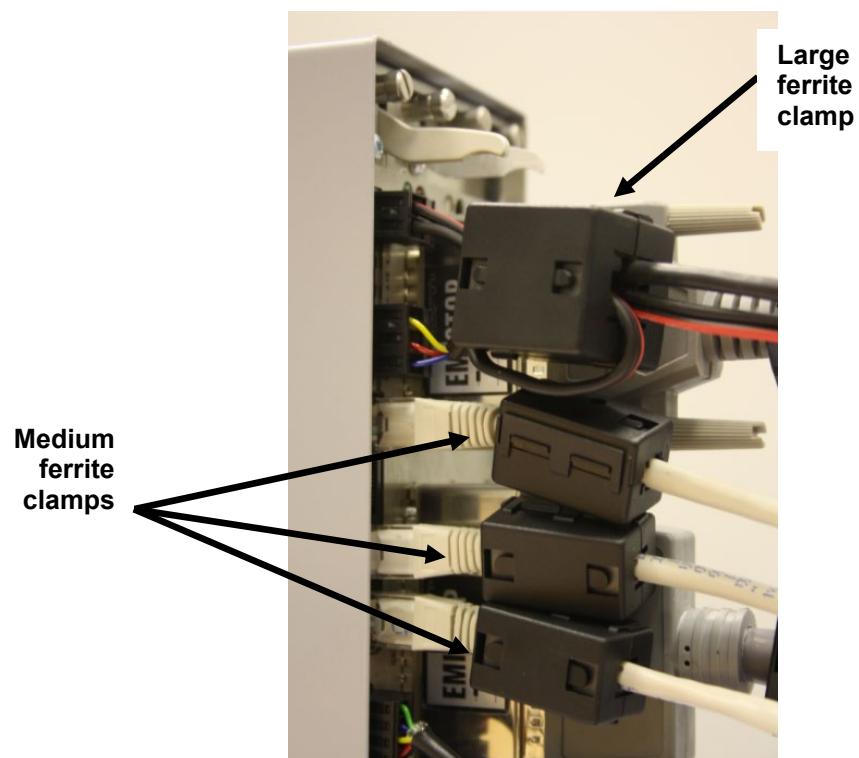
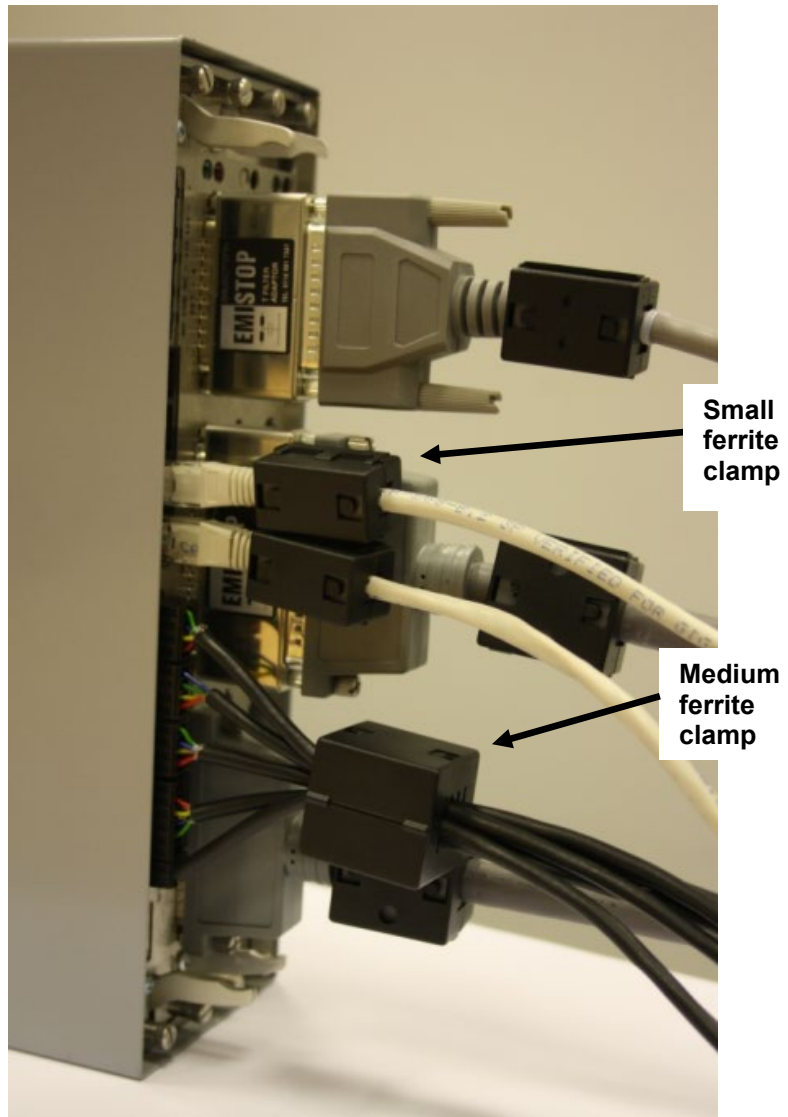

Figure 2-15. Clamps on CPU Module Power & COM Connections

8. Attach a medium ferrite clamp onto the wiring for COMs 5, 6, and 7 and a small ferrite clamp onto the Ethernet cable (see *Figure 2-16*).



*Figure 2-16. Clamps on CPU Module COM and Ethernet Connections*

This completes the installation process and provides the S600+ with EMC protection.

## Chapter 3 – CPU Module

### In This Chapter

3.1	CPU Module (P152).....	3-1
3.2	Power Supply.....	3-4
3.2.1	Watchdog Relay .....	3-4
3.2.2	On-Board Battery Backup.....	3-4
3.3	Communication Ports .....	3-5
3.3.1	RS-232 Serial Port.....	3-6
3.3.2	RS-422/RS-485 Multi-drop Port.....	3-7
3.3.3	Ethernet LAN Ports.....	3-7
3.3.4	Local Operator PC or Remote Display Port .....	3-8
3.4	CPU Connectors and Jumpers.....	3-9
3.5	USB Port.....	3-10
3.6	Additional Technical Information .....	3-10

This chapter provides information on the power and communication connections for the CPU module.



#### Caution

**Failure to exercise proper electrostatic discharge precautions (such as wearing a grounded wrist strap) when accessing the back of the unit or when handling CPU or I/O modules may reset the processor or damage electronic components, resulting in interrupted operations.**

### 3.1 CPU Module (P152)

The CPU module contains the host processor and associated peripherals, which form the heart of the S600+ system. Various plug-in connections are provided on the rear backplate of the CPU module. Refer to *Figure 3-1* for an illustration of the CPU module backplate and to *Figure 3-2* for a schematic of the CPU power terminations. *Figure 3-3* shows the wiring terminations. Additionally, the module uses connectors and jumpers, which are set at the factory prior to shipping. See *Section 3.5, Jumpers* for further information.

It is recommended that all wiring be made with stranded wire that is no larger than 1.5 mm<sup>2</sup> (0.0023 in<sup>2</sup>). For the communication ports, wiring of 1.75 mm<sup>2</sup> to 1.65 mm<sup>2</sup> (0.0027 in<sup>2</sup> to 0.0025 in<sup>2</sup>) is recommended. Power wiring is recommended to be 1.5 mm<sup>2</sup> (0.0023 in<sup>2</sup>). Observe all local wiring practices and regulations.



#### Caution

**Do not use a Mega or similar instrument to check for isolation or continuity between signals on any of the S600+ connectors. These instruments produce voltages far in excess of design parameters and may damage the S600+ or its connectors.**

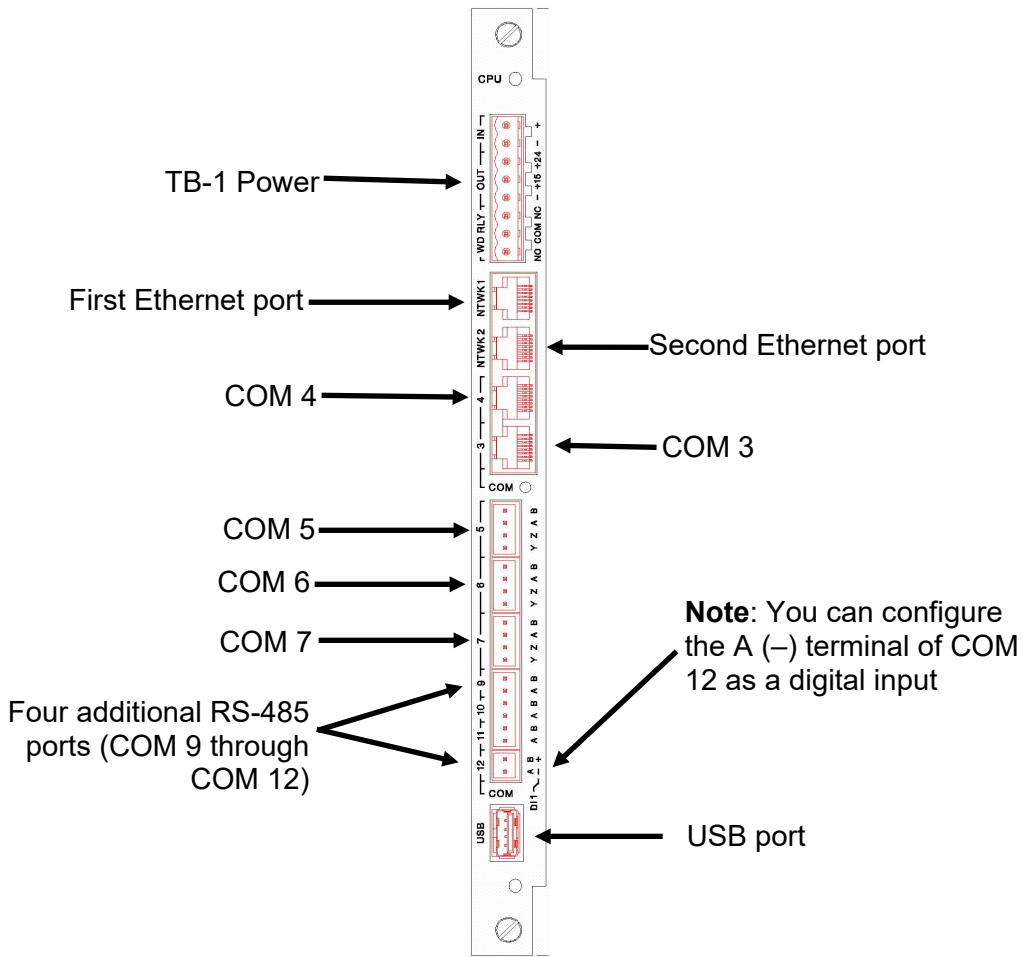

Figure 3-1. CPU Module Backplate



Figure 3-2. CPU Module

CPU MODULE (P152)

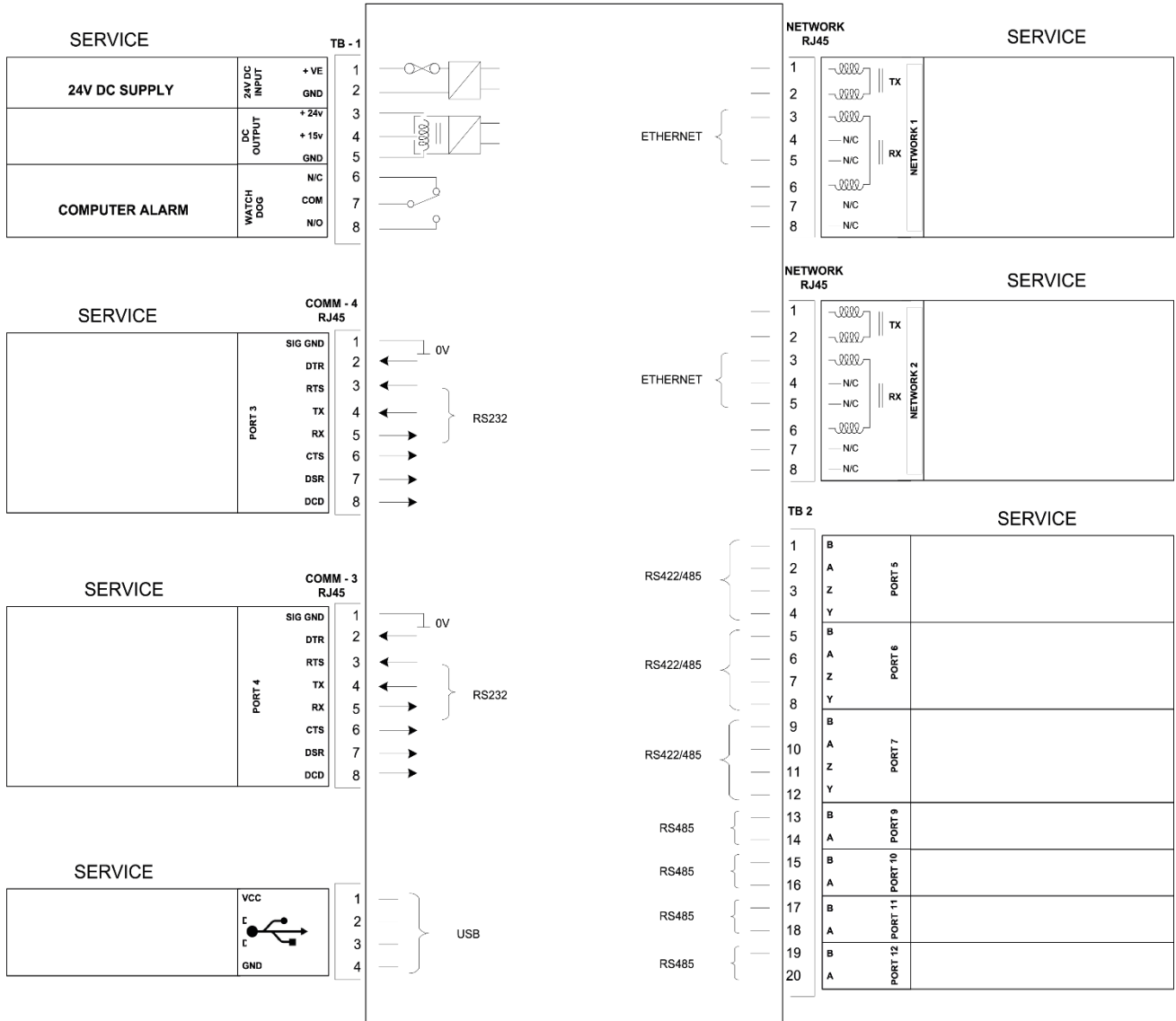

Figure 3-3. CPU Module Terminations

P153 FRONT PANEL

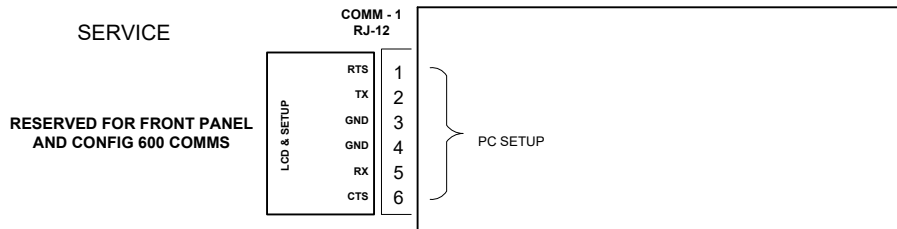

Figure 3-4. Front Panel Terminations

## 3.2 Power Supply

The power connection is a plug-in, standard 5 mm pitch screw terminal block on the CPU module. The power supply connector is labeled TB-1. Refer to *Table 3-1* for the TB-1 pin connections.

Power the S600+ using a nominal 30 Volts dc power source capable of supplying 2 Amps. The S600+ operates between 20 and 32 Volt dc.

The startup in-rush current may draw 6 amps for approximately 100 milliseconds. This in-rush becomes significant when multiple flow computers are connected to the same power supply.

An on-board anti-surge fuse (2.5 Amp slow blow rating) protects the supply line should a fault occur within the unit.

Fully regulated 15 and 24 Volts dc supplies are also available for applications such as powering loops or pre-amplifiers. Resettable thermal fuses protect these outputs.

*Table 3-1. TB-1 Pin Connections (Power)*

Pin	Function
1	+24 V dc INPUT
2	0 V (Return) INPUT
3	+24 V dc OUTPUT (500 mA)
4	+15 V dc OUTPUT (100 mA)
5	0 V (Return) OUTPUT

### 3.2.1 Watchdog Relay

A single pole, double-throw relay with Normally Open or Normally Closed terminals provides the watchdog status from pins 6, 7, and 8 of TB-1. *Table 3-2* shows the TB-1 pin connections. Connection is through plug-in, standard 5 mm pitch screw terminals.

The relay is energized during normal operation. A CPU failure causes the relay to de-energize.

---

**Note:** Contact is rated at 1 Amp, 30 Volts dc and 30 Volts ac, and is a Form “C” contact.

---

*Table 3-2. TB-1 Pin Connections (Watchdog Relay)*

Pin	Function
6	Normally Closed
7	Common
8	Normally Open

### 3.2.2 On-Board Battery Backup

The backup battery (see *Figure 3-2*) retains the contents of the SRAM on the CPU module, the PC-compatible BIOS CMOS memory area, and the calendar clock. The battery, a Lithium 3.0 volt 1500 mAmp/hour unit, is user-replaceable. For further battery specifications, see the technical specification (S600+). To ensure that the battery is



fully functional, the S600+ software routinely performs a regular load test on the unit.

### Replacing the Battery

To replace the backup battery on the CPU module:

---

**Note:** Before beginning this process, ensure that any critical processes the S600+ controls are otherwise managed.

---

1. Power down the S600+.
2. Disconnect wiring from the CPU module.

---

**Note:** Remove the security backplate, if one is installed on the S600+.

---

3. Unscrew the retention screws.
4. Unlatch the ejectors (see *Figure 3-2*) and pull the board clear of the case.
5. Place the CPU module on a flat anti-static surface so that the battery faces up (as shown in *Figure 3-2*).
6. Use a small screwdriver to carefully prise the battery out of its holder.

---

**Note:** The CPU module is designed to hold sufficient charge to provide time (3-5 minutes) for you to replace the battery.

---

7. Replace the battery with an exact duplicate (Lithium 3V 1500 mAh, type CR12600SE, part number S600+BATTERY).
8. Slide the CPU module back into the S600+ case, ensuring that it seats firmly into its connectors.
9. Secure the retention screws.

---

**Note:** If appropriate, replace the EMC backplate.

---

10. Reconnect wiring and apply power to the S600+.

## 3.3 Communication Ports

---

The CPU has 12 standard communication ports: nine serial and two Ethernet (see *Figure 3-1*). *Table 3-3* details the communications ports.

**COM 1-7** Comm ports 1 through 7 are essentially unchanged from previous versions of the S600.

Comm ports 1 and 7 contain internal connections to other boards in the S600+ which are not available for external host or local operator communications. You can use Comm Port 3 or 4 to route Remote Display connections. Comm 1 (located at the base of the faceplate) is reserved for Config Transfer functions.

**COM 9-12** The S600+ adds four new RS-485 serial ports (COM 9 through COM 12), located in the lower half of the CPU module (see *Figure 3-1*).

*Table 3-3. Communication Ports*

Communications Port	Backplate Descriptor	Description
Network 1	NTWK1	Ethernet
Network 2	NTWK2	Ethernet
Comm 4	COM4	RS-232
Comm 3	COM3	RS-232
Comm 5, 6 & 7	TB2, TB3, TB4	RS-422 or RS-485
Comm 9	TB6	
Comm 10	TB6	
Comm 11	TB6	
Comm 12	TB6	
USB		

For information on the communications port on the front panel which can also act as Comm 2, refer to *Chapter 5, Front Panel*.

### 3.3.1 RS-232 Serial Port

The CPU module's backplate provides two RS-232 (RS-232D) communications ports labeled COM3 and COM4. The ports use FCC-68 RJ-45 connectors. The COM3 and COM4 pin connections are shown in *Table 3-4*. *Figure 3-5* shows a sample pin connection.

Converters are commercially available to configure either 9-way D type or 25-way D type connection. The ports support baud rates from 2400 to 57600 bps.

*Table 3-4. COM3 and COM4 Pin Connections*

Pin	Function
1	GND
2	DTR
3	RTS
4	TX
5	RX
6	CTS
7	DSR
8	DCD

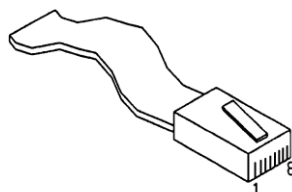

*Figure 3-5. Pin Connections*

The maximum cable length is a function of the baud rate and quality of cable used. For example, a maximum length of 15 m (50 ft) should be used at 19200 bps when using unshielded cable.

Connect ports to the peripheral devices using multi-conductor, shielded cable not longer than 8 meters (approx. 25 feet). We recommended (especially in noisy environments) that you connect the cable screen to protective earth to keep the signal ground separate.

### 3.3.2 RS-422/RS-485 Multi-drop Port

The CPU module provides three RS-422 or RS-485 ports, labeled COM5, COM6, and COM7. These provide high speed/long distance links of up to 57600 bps and 1200 m (4000 ft). The ports use the connector labeled TB-2. *Table 3-5* shows the COM5, COM6, and COM7 pin connections.

---

**Note:** Jumpers on the enhanced CPU module now provide RS-485 linking, so that wire linking is no longer necessary. If the cable is already linked (as in an upgrade), you do not need to remove the linked pairs.

---

*Table 3-5. COM5, COM6, and COM7 Pin Connections*

Channel	Pin	Function
COM5	1	B
	2	A
	3	Z
	4	Y
COM6	5	B
	6	A
	7	Z
	8	Y
COM7	9	B
	10	A
	11	Z
	12	Y

### 3.3.3 Ethernet LAN Ports

The CPU module provides two Ethernet ports – labeled NTWK1 and NTWK2 (ENET0 and ENET1 in Config600 software) – for high-speed communications using an Ethernet Local Area Network (LAN) architecture. The speed of data transfer is 100Mb full duplex when using 100BASE-T twisted pair cable.

These ports use a FCC-68 RJ-45 connector. No hardware configuration or wiring is required for these communications ports.

#### Configuring Two Ethernet Networks

The second generation S600+ CPU module has two Ethernet ports, NTWK1 and NTWK2. To correctly route messages to each network, set the third octet of the IP address of the ENET1 port to a different value than for the ENET0 port. For example, if the IP address for ENET0 is 129.76.69.74, set the third octet of the second Ethernet

port to a different value, such as 129.76.70.74. This correctly routes incoming messages to the relevant host port.

Failure to do this may cause the flow computer to mistakenly attempt to send packages out of the wrong interface causing communication problems. However, if this is required then the following steps can be taken to ensure that when a network cable is disconnected, the associated Ethernet port is disabled.

---

**Note:** This **only** works when using binary.app 06.22 or above.

---

To configure the Ethernet port behaviour when a cable is unplugged:

1. Cold start the FloBoss S600+.
2. Navigate to the **Network Setup** menu (Option 3).
3. Select **Wire Unplug Cfg** (Option 3).
4. Select one of the following options:

Value	Description
<b>Disable Eth Port (Option 1)</b>	Disables the Ethernet port when the cable is unplugged and causes the ping command to fail.
<b>Enable Eth Port (Option 2)</b>	Enables the Ethernet port when the cable is unplugged. This is the <b>default</b> .

5. Return to the cold start menu once the correct option has been selected and restart the machine.

### 3.3.4 Local Operator PC or Remote Display Port

You can configure COM3 or COM4 to connect the S600+ to a remote display or the host PC (COM2).

Use only shielded, multi-conductor cable to connect to the COM3-4 port. It is recommended—particularly in noisy environments—that you connect the cable shield to earth ground to keep the signal ground separate.

#### Connecting to the S600+

You need a special serial cable to connect the host PC to the S600+. A ready-made link cable (part number 3080017) is available for a PC with a 9-pin serial port.

Alternatively, you may fabricate your own link cable using the wiring details in *Figure 3-6*.

---

**Note:** Due to the high baud rate used for the communications between the host PC and the S600+, restrict the maximum cable length to 5 m (15 ft).

---

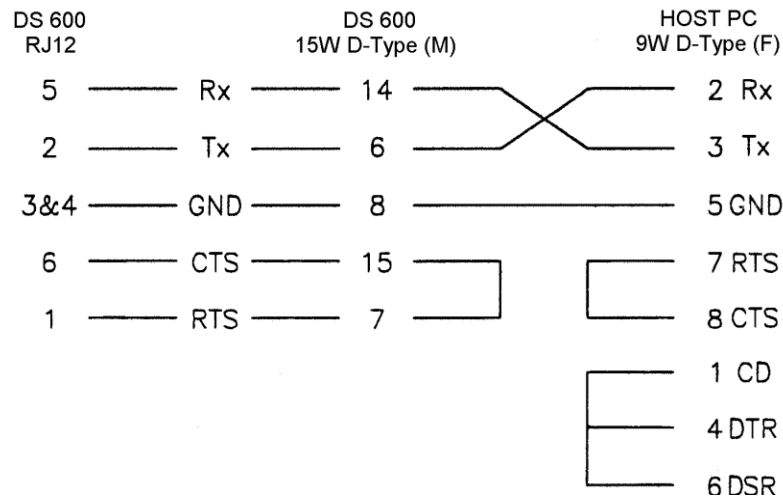

Figure 3-6. Link Cable

### 3.4 CPU Connectors and Jumpers

Table 3-6 shows the connectors and jumpers on the CPU module. This information is for identification purposes only. Do not modify these settings, unless told to do so by the factory.

**Note:** The position values shown in **boldface** are the default configuration settings, which may not apply to your specific configuration.

Table 3-6. CPU Jumpers

Jumper/Connector	Description
P1	Back plane connector
P2	Cold start forced on power up
P3	Security jumper (Off – Level 1 security enabled)
P4	Debug console (factory use only)
P5	Processor programming header (factory use only)
P6	CPLD programming header (factory use only)
P7	Termination resistors for COM5 (1-2 side for ON)
P8	Termination resistors for COM6 (1-2 side for ON)
P9	Termination resistors for COM7 (1-2 side for ON)
P10	RS-422/RS-485 selector for COM5. 1-2, 4-5, 7-8, 10-11 side for RS-422 Jumper 14-15 must always be fitted
P11	RS-422/RS-485 selector for COM6. 1-2, 4-5, 7-8, 10-11 side for RS-422 Jumper 14-15 must always be fitted
P12	RS-422/RS-485 selector for COM7. 1-2, 4-5, 7-8, 10-11 side for RS-422 Jumper 14-15 must always be fitted
P13	Termination resistors for COM10 (1-2 ON)

Jumper/Connector	Description
P14	Termination resistors for COM9 (1-2 ON)
P15	Termination resistors for COM12 (1-2 ON)
P16	
P17	TB6 serial port or digital input mode selector 1-2 and 4-5 for serial port 2-3 and 5-6 for digital input
P18	Termination resistors for COM11 (1-2 ON)
P20	Watchdog Jumper on 2-3 must be selected
P26	Flash write protect
P27	Flash boot selection (NAND/ <b>NOR</b> )

### 3.5 USB Port

Use the USB 2.0 port on the CPU module to export alarm history, event history, and report history information to a USB flash drive.

You access the export facility either through the S600+ front panel or the webserver. Select **Tech/Engineer > USB**. Using the front panel you can also enable or disable the USB port.

**Note:** For detailed instructions, see *Chapter 5, Front Panel*.

### 3.6 Additional Technical Information

Refer to the following technical documentation (available at [www.Emerson.com/EnergyandTransportation](http://www.Emerson.com/EnergyandTransportation)) for additional and most-current information.

*Table 3-7. I/O Module Technical Specifications*

Name	Form Number	Part Number
FloBoss™ S600+ Flow Computer	S600+	D301151X412

## Chapter 4 – Input/Output (I/O)

### In This Chapter

4.1	I/O Module (P144).....	4-1
4.1.1	Analogue Inputs (ANIN).....	4-3
4.1.2	Analogue Outputs (DAC).....	4-5
4.1.3	Digital Inputs (DIGIN).....	4-6
4.1.4	Digital Outputs (DIGOUT).....	4-8
4.1.5	Turbine Pulse Inputs.....	4-9
4.1.6	Pulse Outputs (PULSEOUT).....	4-10
4.1.7	Raw Pulse Output (RAWOUT).....	4-11
4.1.8	Frequency Inputs.....	4-12
4.1.9	PRT/RTD Inputs.....	4-13
4.1.10	Jumper Settings.....	4-14
4.2	Prover Module (P154).....	4-16
4.2.1	Digital Inputs (DIGIN).....	4-19
4.2.2	Digital Outputs (DIGOUT).....	4-20
4.2.3	Turbine Pulse Inputs.....	4-21
4.2.4	Pulse Outputs (PULSEOUT).....	4-22
4.2.5	Frequency Inputs.....	4-23
4.2.6	Raw Pulse Output (RAWOUT).....	4-24
4.2.7	Jumper Settings.....	4-24
4.3	HART Module (P188).....	4-25
4.4	Mezzanine Module (P148).....	4-28

This chapter provides information on plug-in connector blocks and field wiring (ANIN and PRT signals) for the I/O, Prover, and HART modules. This chapter also discusses the pulse counting mezzanine module (P148) which is included as a daughter board on the IO and Prover boards.



#### Caution

**Failure to exercise proper electrostatic discharge precautions (such as wearing a grounded wrist strap) when accessing the back of the unit or when handling CPU or I/O modules may reset the processor or damage electronic components, resulting in interrupted operations**

Perform all wiring with stranded wire no larger than 1.75mm<sup>2</sup>. Observe all local wiring practices and regulations.



#### Caution

**Do not use a Mega or similar instrument to check for isolation or continuity between signals on any of the S600+ connectors. These instruments produce voltages far in excess of design parameters and may damage the S600+.**

### 4.1 I/O Module (P144)

The I/O module (P144) measures process signals the CPU uses while running the flow computer functions. The module provides 12 analogue inputs (AI), 4 analogue outputs (AO), 16 digital inputs (DI), 12 digital outputs (DO), 4 pulse inputs (PI), 5 pulse outputs (PO), 3 frequency (density) inputs, and 3 PRT/RTD inputs. Refer to *Figure 4-2* for the I/O module terminations.

For field wiring, the module provides three low-density D-type connectors: SKT-A, SKT-B, and SKT-C (refer to *Figure 4-1*).

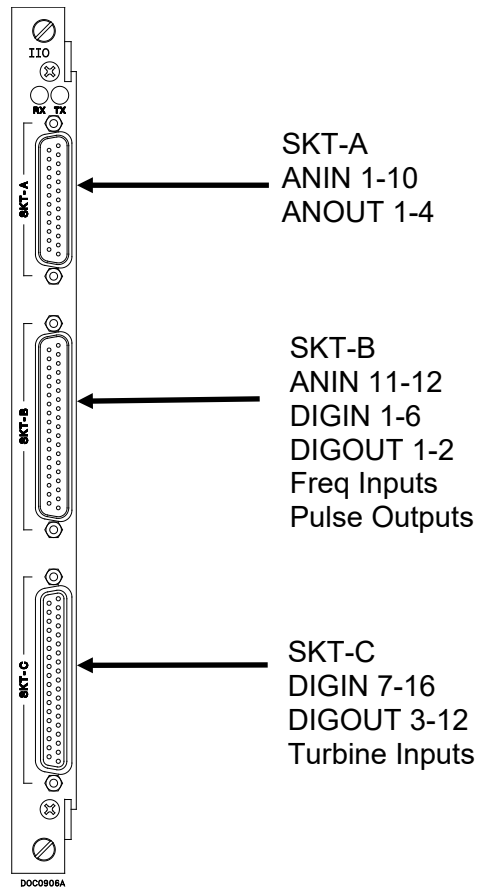

Figure 4-1. I/O Module (P144)

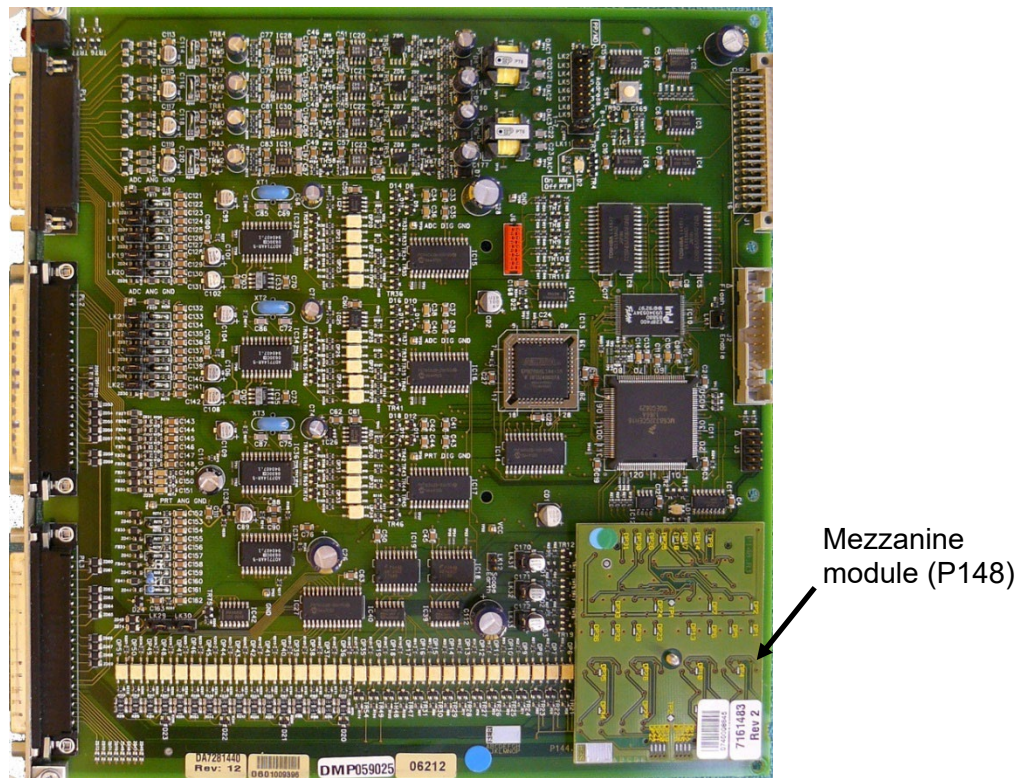

Figure 4-2. Example I/O Module (with Mezzanine Module)



I/O MODULE (P144)

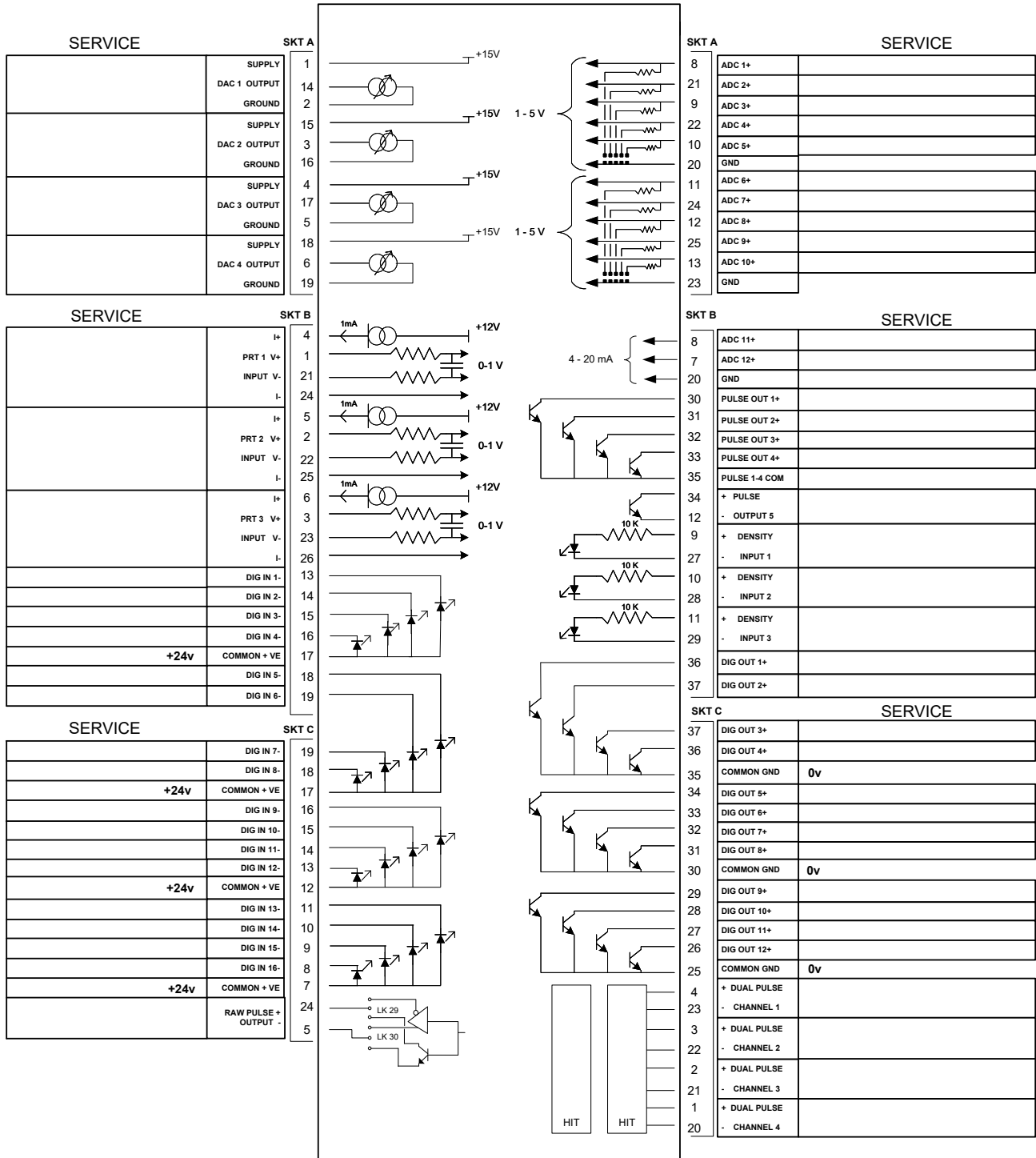

Figure 4-3. I/O Module Terminations

### 4.1.1 Analogue Inputs (ANIN)

Each I/O module has two fully floating A/D converters, each measuring five single-ended analogue input (ANIN) channels. Each channel (ANIN 1-10) is configurable within a 0 to 5.25 volt or 0 to 22 mA input range. The module also provides two current-only inputs (ANIN 11 and 12), for a total of 12 analogue inputs.

The primary measurement for ANIN 1-10 is voltage, which is compared to a stable reference source. The channels are configurable to current using a bit link (jumper) on the module to place a high accuracy calibrated shunt resistor in parallel with the input. Refer to *Figures 4-4* and *4-5*.

**⚠ Caution** Set the channels for each A/D converter to the same value to guarantee accuracy. Set all channels ANIN 1-5 on the first A/D converter for either voltage or current. Set all channels ANIN 6-10 on the second A/D converter for either voltage or current. Refer to *Table 4-13* for jumper settings on the I/O module.

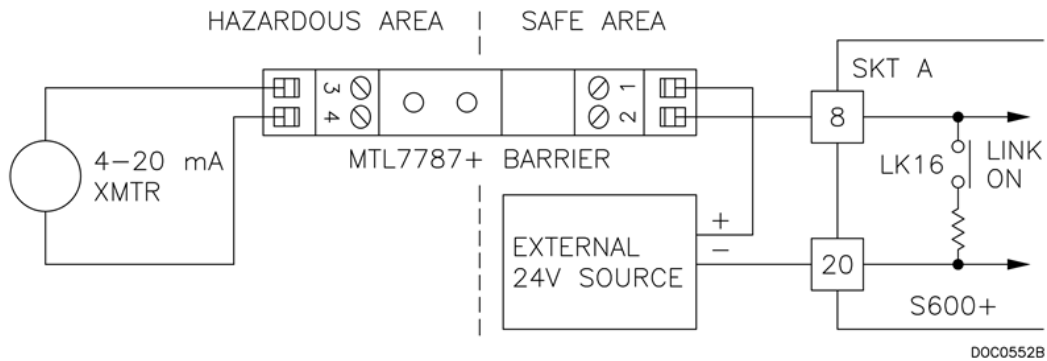

Figure 4-4. Analogue Input Schematic (with IS Barrier and using Internal Resistor)

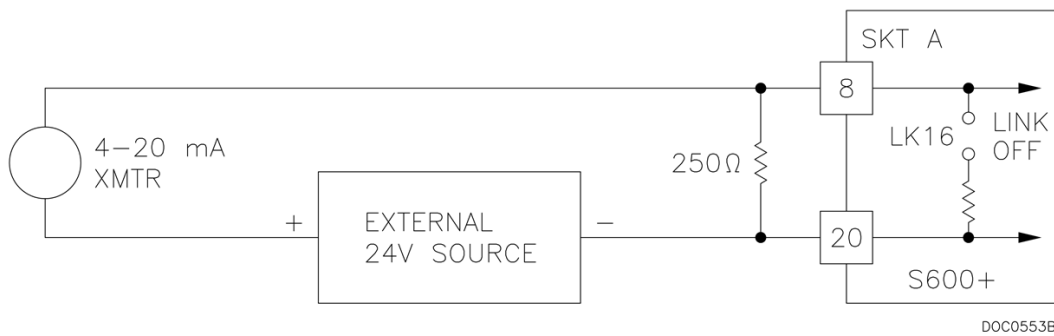

Figure 4-5. Analogue Input Schematic (without IS Barrier and using External Resistor)

The ANIN channels use the connectors labeled SKT-A and SKT-B, which are located on the backplate of the I/O module. Channels CH1 to CH10 are located on connector SKT-A. Channels CH11 and CH12 are located on connector SKT-B. Refer to *Tables 4-1* and *4-2* for the ANIN pin connectors.

Table 4-1. ANIN Pin Connections for SKT-A

Pin	Function
8	ANIN-CH1
21	ANIN-CH2
9	ANIN-CH3
22	ANIN-CH4
10	ANIN-CH5
20	RETURN CH1-5
11	ANIN-CH6
24	ANIN-CH7
12	ANIN-CH8
25	ANIN-CH9
13	ANIN-CH10
23	RETURN CH6-10

Table 4-2. ANIN Pin Connections for SKT-B

Pin	Function
8	ANIN-CH11 (current)
7	ANIN-CH12 (current)
20	GND

#### 4.1.2 Analogue Outputs (DAC)

The S600+ supports four analogue outputs (D/A Converter). Each D/A Converter channel is fully floating and provides its own floating supply. Loads of up to a 650-ohm loop impedance can be connected directly. The unit can be used in either source or sink configuration. Refer to *Figures 4-6, 4-7, and 4-8*.

The D/A Converter output channels use the connector labeled SKT-A, which is located on the backplate of the I/O module. Refer to *Table 4-3* for the D/A Converter output pin connections on the back of the I/O module.

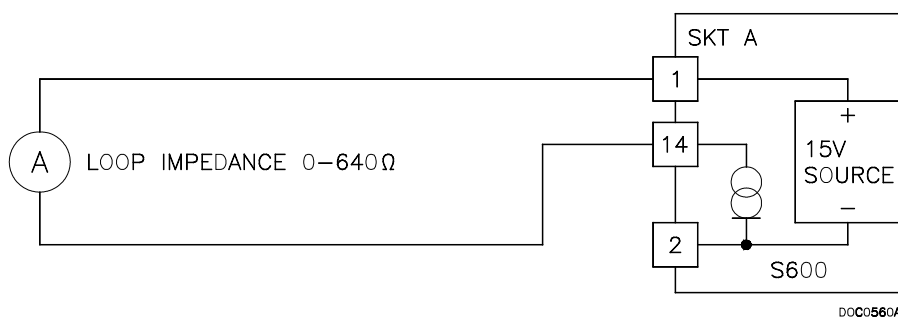

Figure 4-6. Analogue Output Schematic (S600+-Powered)

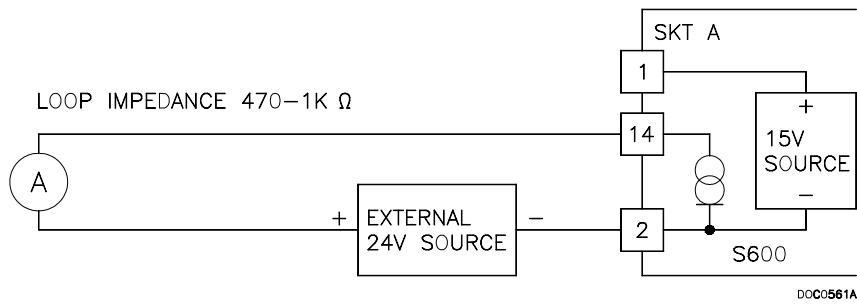

Figure 4-7. Analogue Output Schematic (Externally Powered Device)

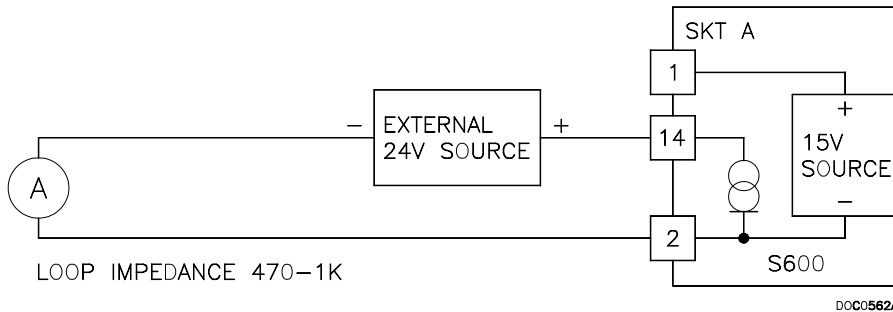

Figure 4-8. Analogue Output Schematic (Externally Powered through S600+)

Table 4-3. D/A Converter Output Pin Connections for SKT-A

Pin	Function
1	DAC-CH1 +15 V SOURCE
14	DAC-CH1 SINK
2	DAC-CH1 0 VDC
15	DAC-CH2 +15 V SOURCE
3	DAC-CH2 SINK
16	DAC-CH2 0 VDC
4	DAC-CH3 +15 V SOURCE
17	DAC-CH3 SINK
5	DAC-CH3 0 VDC
18	DAC-CH4 +15 V SOURCE
6	DAC-CH4 SINK
19	DAC-CH4 0 VDC

### 4.1.3 Digital Inputs (DIGIN)

Each plug-in module provides 16 optically isolated digital inputs (DIGIN). The digital inputs have been grouped into four banks of 4-off single-ended inputs with one common feed. Refer to *Figures 4-9 and 4-10*.

The sample period is less than 1 second.

The DIGIN channels use the connectors labeled SKT-B and SKT-C, which are located on the backplate of the I/O module. Refer to *Tables 4-4 and 4-5* for the DIGIN pin connections.

**Note:** You must connect the feed lines (such as pin 17 on SKT-B) to a 24 Volts dc source. The DIGIN lines (such as pin 13 on SKT-B) expect typical “open collector” (referenced to GND) connections.

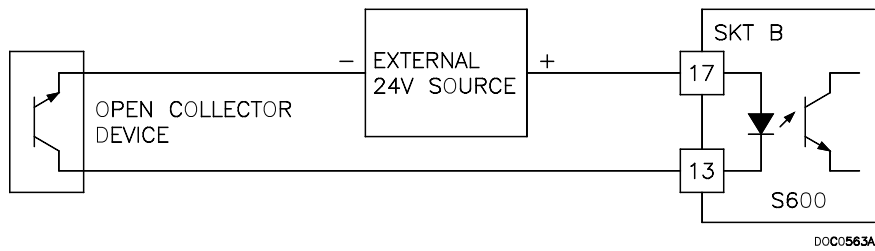

Figure 4-9. Digital Input Schematic (Open Collector Device)

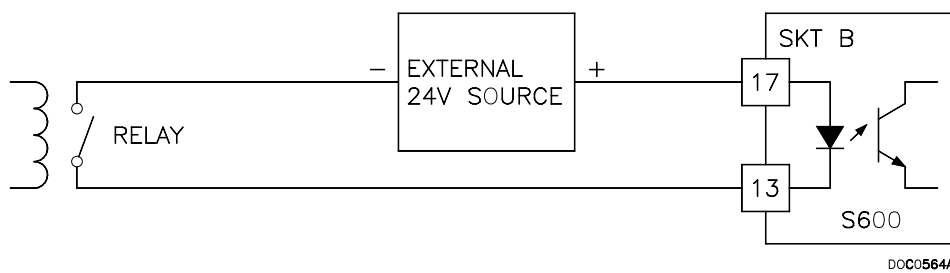

Figure 4-10. Digital Input Schematic (Relay)

Table 4-4. DIGIN Pin Connections for SKT-B

Pin	Function
13	DIGIN-CH1
14	DIGIN-CH2
15	DIGIN-CH3
16	DIGIN-CH4
17	RETURN CH1-4
18	DIGIN-CH5
19	DIGIN-CH6

Table 4-5. DIGIN Pin Connections for SKT-C

Pin	Function
19	DIGIN-CH7
18	DIGIN-CH8
17	RETURN CH5-8
16	DIGIN-CH9
15	DIGIN-CH10
14	DIGIN-CH11
13	DIGIN-CH12
12	RETURN CH9-12
11	DIGIN-CH13
10	DIGIN-CH14
9	DIGIN-CH15
8	DIGIN-CH16
7	RETURN CH13-16

### 4.1.4 Digital Outputs (DIGOUT)

The S600+ supports 12 digital output (DIGOUT) channels, which are open collector type outputs. The maximum current rating is 100 mAmps at 24 Volts dc. Output frequencies up to 0.5 Hz are possible.

Carefully check the DC polarity using an external DC supply in series with the load. When using inductive loads (such as relay coils), place a diode across the load. Refer to *Figures 4-11* and *4-12*.

The DIGOUT channels use the connectors labeled SKT-B and SKT-C, which are located on the backplate of the I/O module. Refer to *Tables 4-6* and *4-7* for the DIGOUT pin connections.

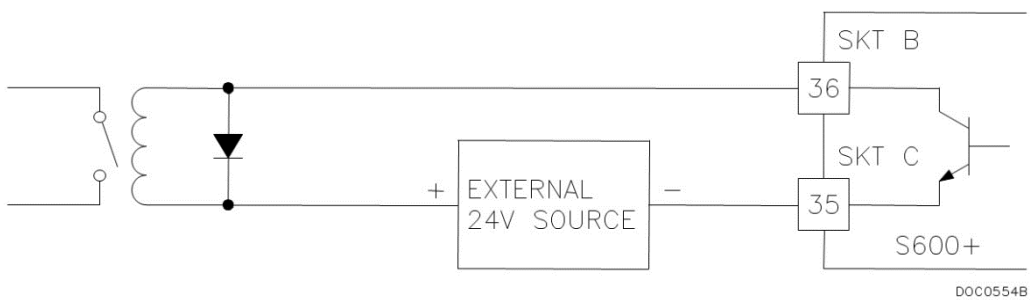

Figure 4-11. Digital Output Schematic (Relay)

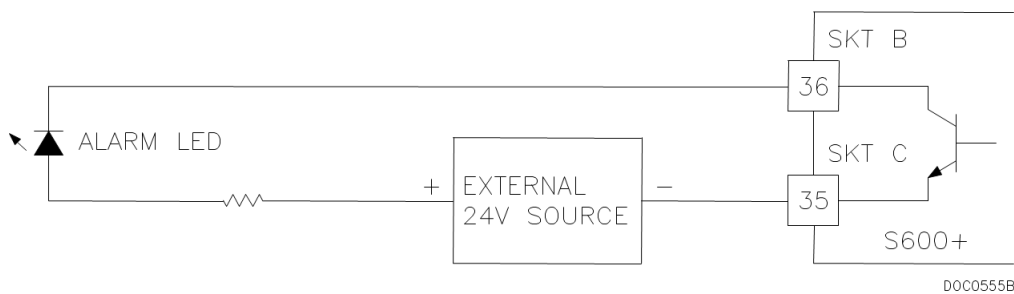

Figure 4-12. Digital Output Schematic (24V Switched Indicator)

Table 4-6. DIGOUT Pin Connections for SKT-B

Pin	Function
36	DIGOUT-CH1
37	DIGOUT-CH2

Table 4-7. DIGOUT Pin Connections for SKT-C

Pin	Function
37	DIGOUT-CH3
36	DIGOUT-CH4
35	RETURN CH1-4
34	DIGOUT-CH5
33	DIGOUT-CH6
32	DIGOUT-CH7
31	DIGOUT-CH8
30	RETURN CH5-8
29	DIGOUT-CH9
28	DIGOUT-CH10
27	DIGOUT-CH11
26	DIGOUT-CH12
25	RETURN CH9-12

### 4.1.5 Turbine Pulse Inputs

The mezzanine module (P148) provides the I/O module with support for four pulse inputs either independently or as two pairs ("Dual Pulse Mode"). Generally, the pulse inputs perform dual pulse measurement, such as in turbine applications. In dual pulse mode, you can enable level A or B pulse checking.

Each input has an input range of 1 Hz to 10 kHz. Each channel has live integrity checking. If cabling faults develop or if the pre-amp power fails, the software activates a configurable circuit fail alarm.

The electrical connection for these inputs depends on which DPR mezzanine module is fitted to the I/O module. The dual mezzanine module accepts pulse inputs from 3.5 Volts dc to 24 Volts dc, when wired as shown in *Figures 4-13* and *4-14*. The module cannot accept NAMUR or current mode preamps without external devices.

The mezzanine module can interface to a variety of preamps, including the Mercury (formerly Spectra-Tek) F 106 and ST106, Instromet MK15, Faure Herman FH71 2-wire, Faure Herman FH71 3-wire, ITT Barton 818U, and Daniel 1838 Preamp.

*Table 4-8* shows the dual pulse input pin connections.

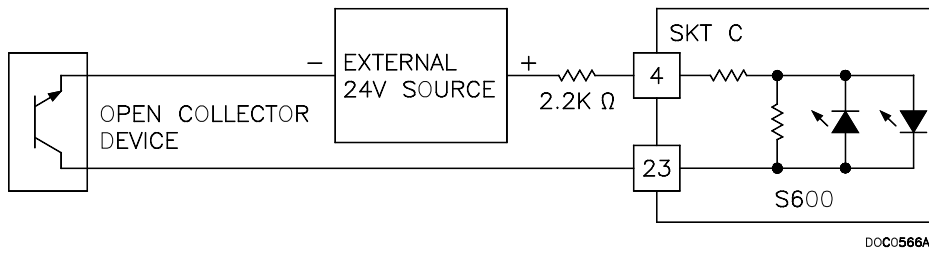

Figure 4-13. Pulse Input Schematic (with 12V P148 Mezzanine Module)

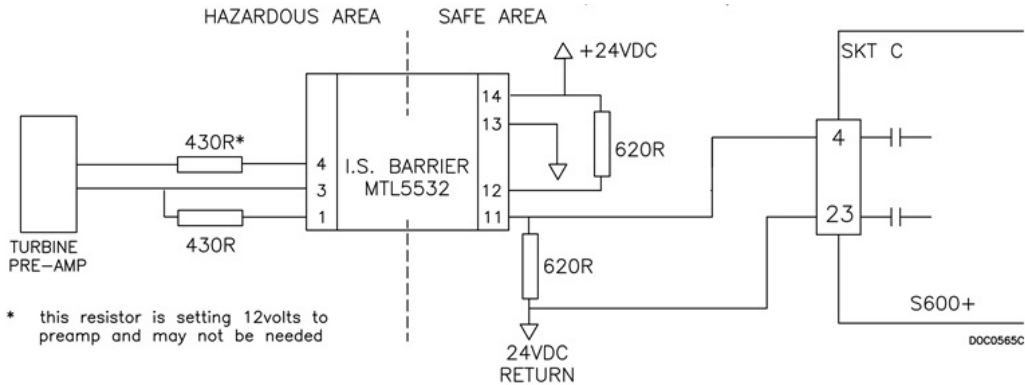

Figure 4-14. Pulse Input Schematic (with 24 V P148 Mezzanine Module)

Table 4-8. Dual Pulse Input Pin Connections for SKT-C

Pin	Function
4	SINGLE/DUAL PULSE-CH1+
23	SINGLE/DUAL PULSE-CH1-
3	SINGLE/DUAL PULSE-CH2+
22	SINGLE/DUAL PULSE-CH2-
2	SINGLE/DUAL PULSE-CH3+
21	SINGLE/DUAL PULSE-CH3-
1	SINGLE/DUAL PULSE-CH4+
20	SINGLE/DUAL PULSE-CH4-

### 4.1.6 Pulse Outputs (PULSEOUT)

The system supports five programmable pulse output channels (PULSEOUT), which are typically used for electronic counters or sampler control. Refer to Figure 4-15.

Table 4-9 shows the PULSEOUT pin connections.

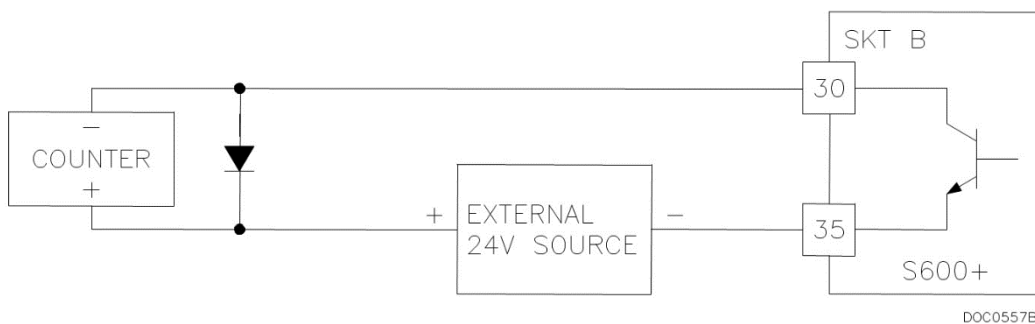

Figure 4-15. Pulse Output Schematic



Table 4-9. PULSEOUT Pin Connections for SKT-B

Pin	Function
30	PULSEOUT-CH1
31	PULSEOUT-CH2
32	PULSEOUT-CH3
33	PULSEOUT-CH4
35	RETURN CH1-4
34	PULSEOUT-CH5
12	RETURN CH5

### 4.1.7 Raw Pulse Output (RAWOUT)

The S600+ supports a single raw pulse output, typically used in prover applications to mimic the turbine signals and send them to the prover mezzanine card. Refer to *Figure 4-16*. A 1K ohm resistor is required if the pulse rate on the prover bus exceeds 1 KHz, if there are more than three S600+s, or if more than 20 m of cable is required.

*Table 4-10* shows the RAWOUT pin connections.

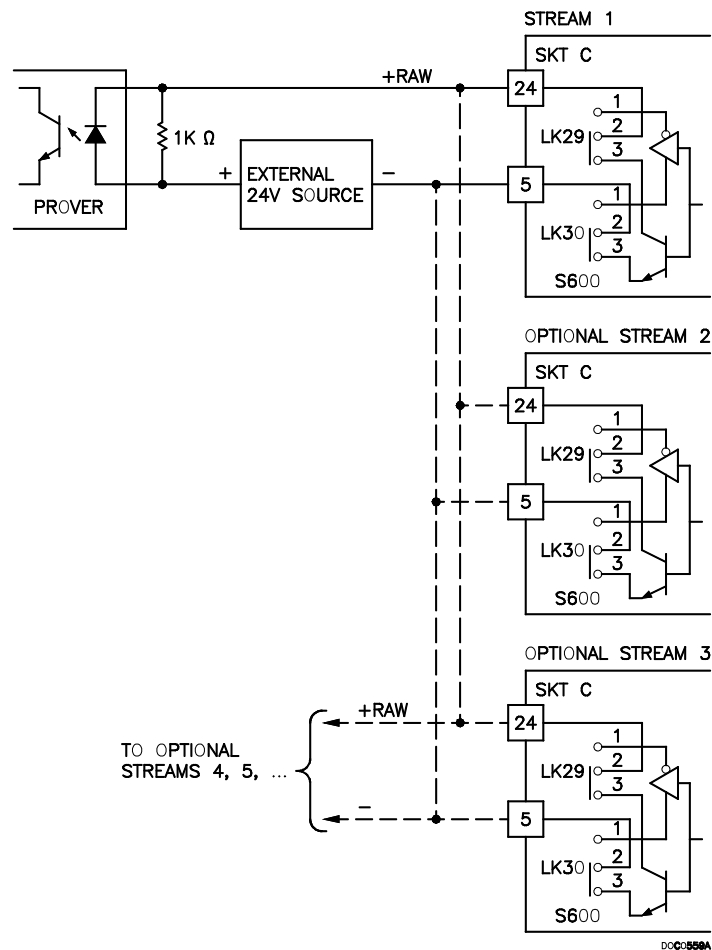

Figure 4-16. Raw Pulse Output Schematic

Table 4-10. Raw Pulse Output Pin Connections for SKT-C

Pin	Function
24	Raw Output
5	Return

### 4.1.8 Frequency Inputs

The S600+ typically uses the three supported frequency inputs for density transducer signals. Each input has an input range of 0 to 10 KHz. Jumpers on the module enable you to set the inputs to be AC- or DC-coupled. Refer to *Figures 4-17* and *4-18*.

The frequency input channels use the SKT-B connector, which is located on the backplate of the I/O module. *Table 4-11* shows the frequency input pin connections.

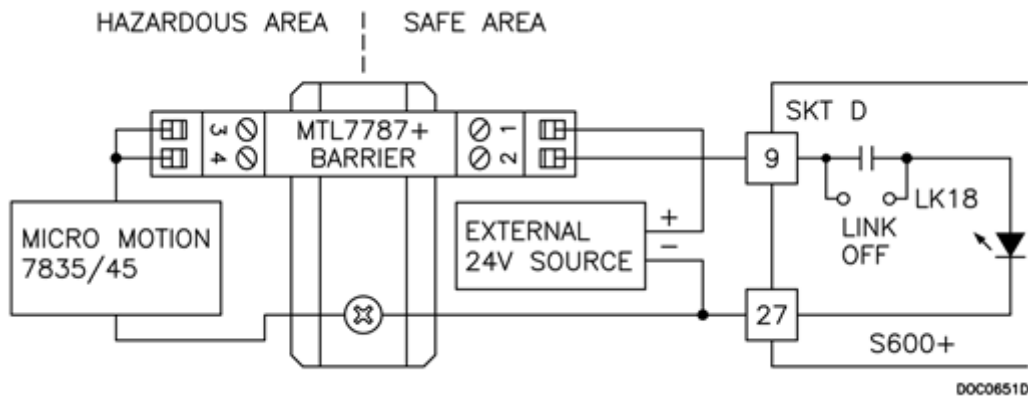

Figure 4-17. Frequency Input Schematic (with IS Barrier and AC-Coupled)

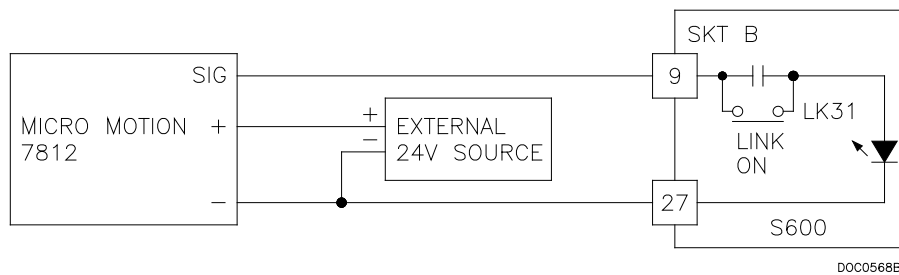

Figure 4-18. Frequency Input Schematic (without IS Barrier and with DC-Coupled)

**Note:** The Micro Motion (previously Solartron) devices may still have their previous manufacturer's labels.

Using MTL 5532 Isolator in two wire mode.

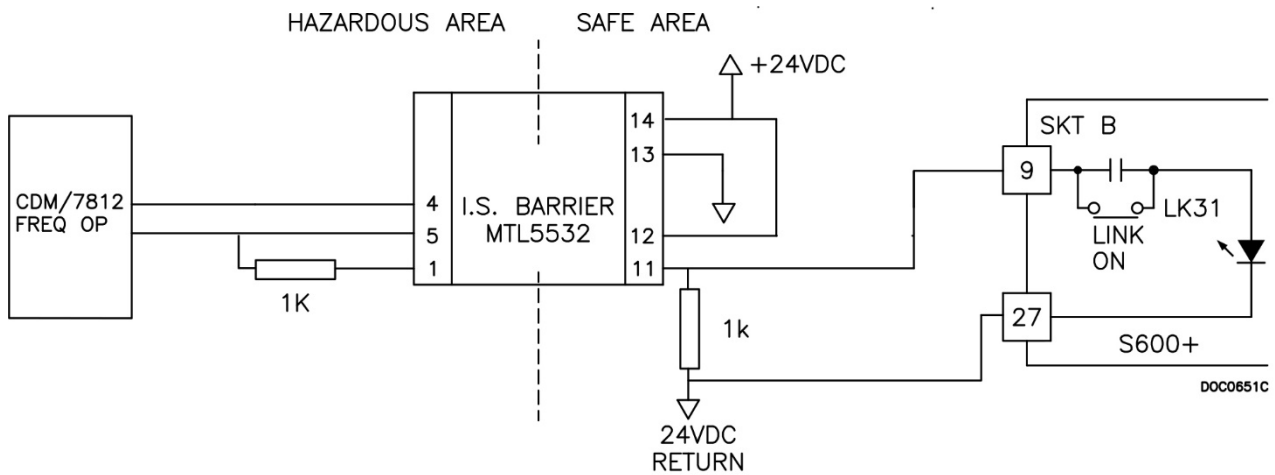

Figure 4-19. Frequency Input Schematic (with MTL Isolator in Two-wire Mode)

Table 4-11. Frequency Input Pin Connections for SKT-B

Pin	Function
9	FREQUENCY-CH1+
27	FREQUENCY-CH1-
10	FREQUENCY-CH2+
28	FREQUENCY-CH2-
11	FREQUENCY-CH3+
29	FREQUENCY-CH3-

#### 4.1.9 PRT/RTD Inputs

The S600+ supports three Platinum Resistance Thermometer (PRT)/Resistance Temperature Detector (RTD) inputs. These inputs are suitable for Class A, 4-wire PRT devices that conform to the BS EN 60751:1996 standard. The temperature measurement range is  $-100$  to  $+200^{\circ}\text{C}$  ( $-148$  to  $+392^{\circ}\text{F}$ ). The S600+ supports three styles of PRT/RTD probes:

- DIN (coefficient of 0.00385 ohm/ohms degrees Celsius).
- American Standard (coefficient of 0.003926 ohm/ohms degrees Centigrade).
- Calendar Van Dusen equations (used to support newer curves based on the user A, B, C, and R0 coefficients).

The DIN 43760 selection is typical in Europe and common in the United States, while the American Standard selection coefficient (alpha) is still common for circumstances where a slightly purer platinum is used to effect a higher absolute accuracy. You use the Config600 software to configure the style of PRT/RTD input.

Refer to *Figure 4-20* for a wiring schematic. *Table 4-12* shows the PRT/RTD input pin connections.

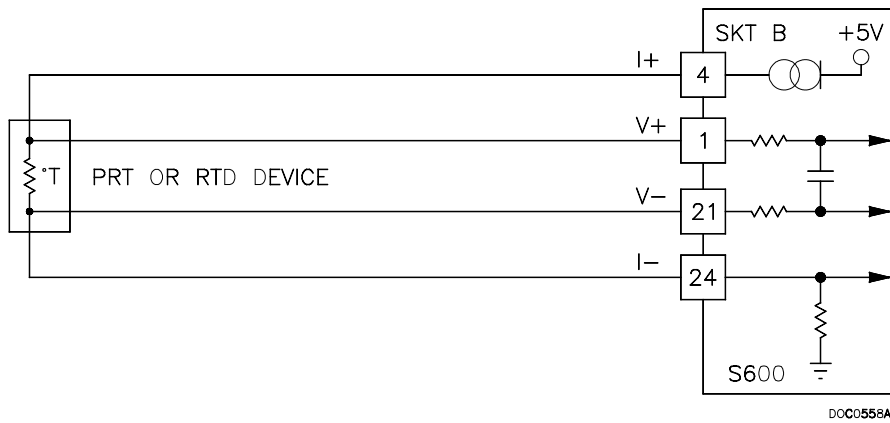

Figure 4-20. PRT/RTD Input Schematic

Table 4-12. PRT/PRD Input Pin Connections for SKT-B

Pin	Function
4	PRT-CH1 I+
1	PRT-CH1 V+
21	PRT-CH1 V-
24	PRT-CH1 I-
5	PRT-CH2 I+
2	PRT-CH2 V+
22	PRT-CH2 V-
25	PRT-CH2 I-
6	PRT-CH3 I+
3	PRT-CH3 V+
23	PRT-CH3 V-
26	PRT-CH3 I-

#### 4.1.10 Jumper Settings

The boldface entries in the Position column on *Table 4-13* are the default configuration settings. These may not apply to your specific configuration. **Do not** change the jumpers settings unless told to do so by the factory.

**Note:** Point-to-point communications for the I/O module require jumper 2 to be ON. Multiplex (MUX) communications require jumper 2 to be OFF.

Table 4-13. I/O Module Jumper Settings

Jumper	Position	Descriptions
<b>Flash</b>		
LK1	ON	Flash Write Enable
	OFF	Flash Write Protected
<b>Node Address</b> (see Table 4-14)		
LK2	ON	Point to Point mode enabled
	OFF	Point to Point mode disabled
LK3 – LK10		Multiplex (MUX) Addresses – see <i>Table 4-14</i>
LK11	ON/OFF	Communications Mode – Off is only supported option
LK12	ON/OFF	Oscilloscope Earth
LK13, LK14, LK15		Not Used
<b>A/D Converter Shunts</b>		
LK16 <sup>1</sup>	ON	ADC CH1 – Current Mode
	OFF	ADC CH1 – Voltage Mode
LK17 <sup>1</sup>	ON	ADC CH2 – Current Mode
	OFF	ADC CH2 – Voltage Mode
LK18 <sup>1</sup>	ON	ADC CH3 – Current Mode
	OFF	ADC CH3 – Voltage Mode
LK19 <sup>1</sup>	ON	ADC CH4 – Current Mode
	OFF	ADC CH4 – Voltage Mode
LK20 <sup>1</sup>	ON	ADC CH5 – Current Mode
	OFF	ADC CH5 – Voltage Mode
LK21 <sup>1</sup>	ON	ADC CH6 – Current Mode
	OFF	ADC CH6 – Voltage Mode
LK22 <sup>1</sup>	ON	ADC CH7 – Current Mode
	OFF	ADC CH7 – Voltage Mode
LK23 <sup>1</sup>	ON	ADC CH8 – Current Mode
	OFF	ADC CH8 – Voltage Mode
LK24 <sup>1</sup>	ON	ADC CH9 – Current Mode
	OFF	ADC CH9 – Voltage Mode
LK25 <sup>1</sup>	ON	ADC CH10 – Current Mode
	OFF	ADC CH10 – Voltage Mode
LK26, LK27, LK28		Cannot be changed.
LK29, LK30	1-2/2-3	Open Collector Mode (2-3). 2-3 is only supported option.
<b>Frequency Output Modes</b>		
LK31	ON	FRQ 01 – DC Coupled
	OFF	FRQ 01 – AC Coupled
LK32	ON	FRQ 02 – DC Coupled
	OFF	FRQ 02 – AC Coupled
LK33	ON	FRQ 03 – DC Coupled
	OFF	FRQ 03 – AC Coupled

<sup>1</sup>A/D Converter Shunts are configured in groups of five and must be used together as current **or** voltage. Fit LK16 through LK19 as a set. Fit LK21 through LK25 as a set.

Table 4-14. Multiplex Mode Addressing

Address	LK3	LK4	LK5	LK6	LK7	LK8	LK9	LK10	Comment
0	N/A	N/A	N/A	N/A	N/A	N/A	N/A	1-2	Not a valid address
1	OFF	OFF	OFF	OFF	OFF	OFF	<b>ON</b>	1-2	First or only board
2	OFF	OFF	OFF	OFF	OFF	<b>ON</b>	OFF	1-2	Second board
3	OFF	OFF	OFF	OFF	<b>ON</b>	OFF	OFF	1-2	
4	OFF	OFF	OFF	<b>ON</b>	OFF	OFF	OFF	1-2	
5	OFF	OFF	<b>ON</b>	OFF	OFF	OFF	OFF	1-2	
6	OFF	<b>ON</b>	OFF	OFF	OFF	OFF	OFF	1-2	
7	<b>ON</b>	OFF	OFF	OFF	OFF	OFF	OFF	1-2	
8	N/A	N/A	N/A	N/A	N/A	N/A	N/A	2-3	Not a valid address
9	OFF	OFF	OFF	OFF	OFF	OFF	<b>ON</b>	2-3	
10	OFF	OFF	OFF	OFF	OFF	<b>ON</b>	OFF	2-3	
11	OFF	OFF	OFF	OFF	<b>ON</b>	OFF	OFF	2-3	
12	OFF	OFF	OFF	<b>ON</b>	OFF	OFF	OFF	2-3	
13	OFF	OFF	<b>ON</b>	OFF	OFF	OFF	OFF	2-3	
14	OFF	<b>ON</b>	OFF	OFF	OFF	OFF	OFF	2-3	
15	<b>ON</b>	OFF	OFF	OFF	OFF	OFF	OFF	2-3	

## 4.2 Prover Module (P154)

The dedicated Prover interface module (P154) has been designed to work with compact or small-volume provers; unidirectional provers; bi-directional provers; and Master Meter provers having one, two, or four detector switches. The Prover module contains high-resolution timing circuits, which enable you to use dual chronometry methods. These increase the apparent resolution for instances when insufficient meter pulses are present for the prover volume. You can use the S600+ for automatic prover sequences, since it provides 32 digital inputs, 12 digital outputs, 2 frequency (density) inputs, and 4 hardware-assisted pulse outputs. Refer to *Figure 4-22* for the Prover module terminations.

**Note:** The Prover module has no analog functions.

For field wiring, the module has three low density D-type connectors: SKT-D, SKT-E, and SKT-F. Refer to *Figure 4-21*.

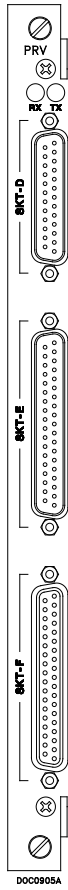

Figure 4-21. Prover Module (P154)

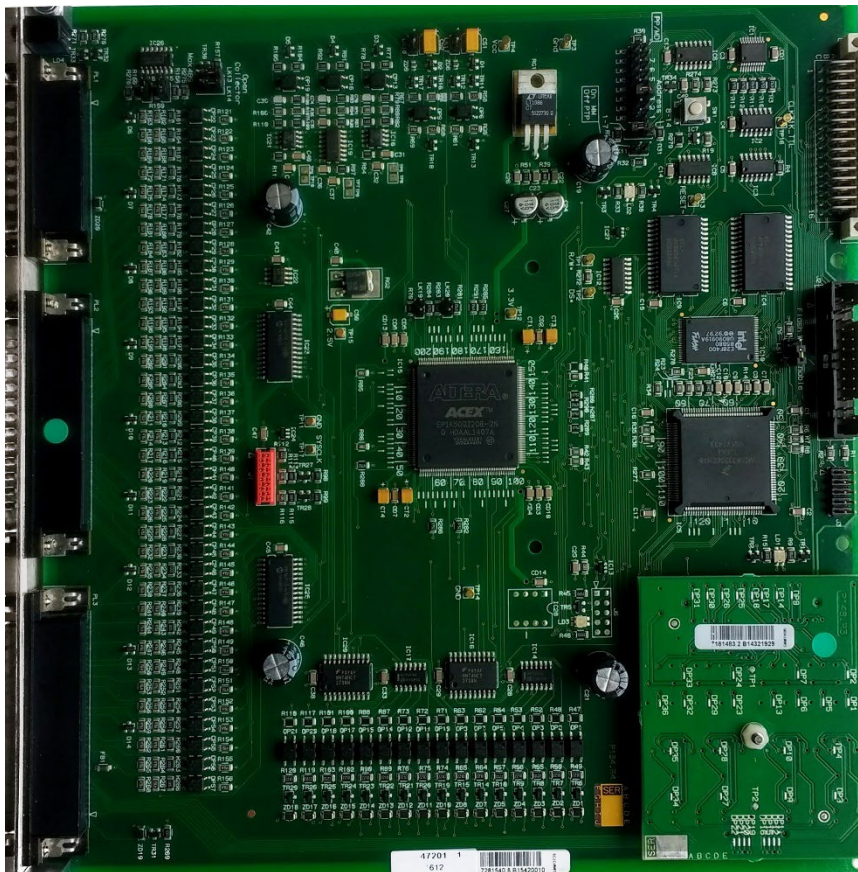

Figure 4-22. Prover Module

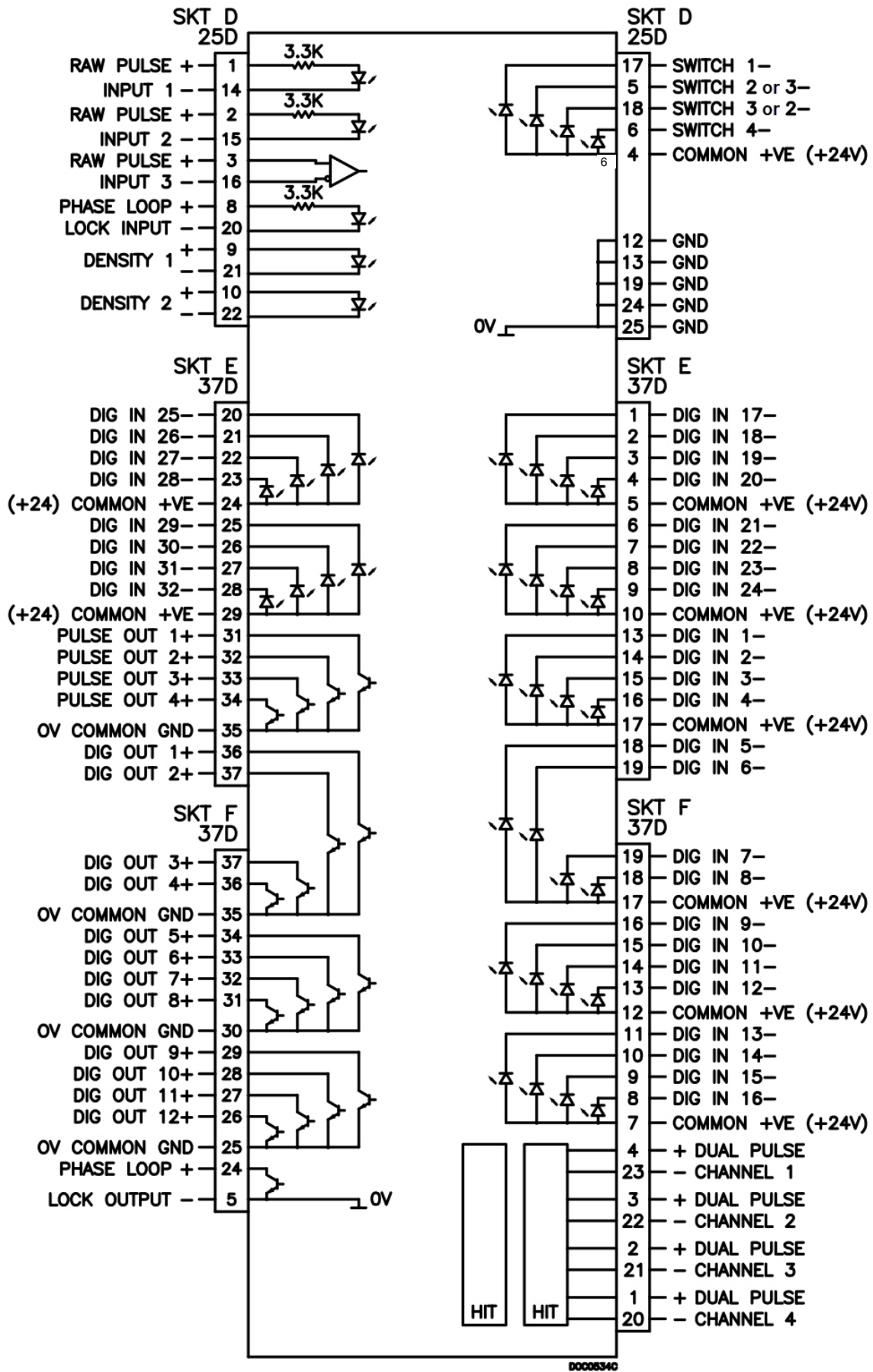

Figure 4-23. Prover Module Terminations



**Note:** The field wiring for sphere switches on SKT D is dependent on the number of switches you are connecting:

- **For 1 switch** (2 sphere detectors wired in parallel), use Pin 17.
- **For two switches**, use Pin 17 (Switch 1) and Pin 5 (Switch 2).
- **For four switches**, use Pin 17 (Switch 1), Pin 18 (Switch 2), Pin 5 (Switch 3), and Pin 6 (Switch 4).

## 4.2.1 Digital Inputs (DIGIN)

Each plug-in module has 32 optically-isolated digital inputs (DIGIN). The digital inputs have been grouped into four banks of 4-off single-ended inputs with one common feed.

The sample period is less than 1 second.

The DIGIN channels use the SKT-E and SKT-F connectors located on the backplate of the Prover module. Refer to *Tables 4-15* and *4-16* for the DIGIN pin connections.

**Note:** You must connect the return lines (such as pin 17 on SKT-E) to a 24 Volts dc source. The DIGIN lines (such as pin 13 on SKT-E) expect typical “open collector” (referenced to GND) connections.

Refer to *Figures 4-24* and *4-25* for field wiring schematics.

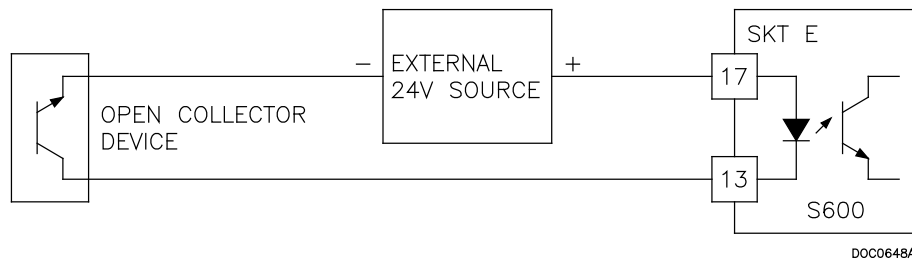

*Figure 4-24. Digital Input Schematic (Open Collector Device)*

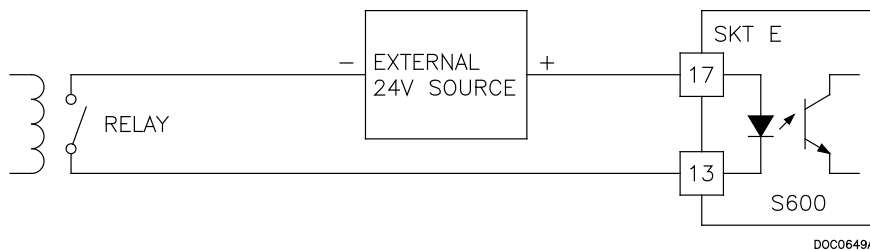

*Figure 4-25. Digital Input Schematic (Relay)*

*Table 4-15. DIGIN Pin Connections for SKT-E*

Pin	Function
13	DIGIN-CH1
14	DIGIN-CH2

Pin	Function
15	DIGIN-CH3
16	DIGIN-CH4
17	RETURN CH1-4
18	DIGIN-CH5
19	DIGIN-CH6
1	DIGIN CH-17
2	DIGIN CH-18
3	DIGIN CH-19
4	DIGIN CH-20
5	RETURN CH-17-20
6	DIGIN CH-21
7	DIGIN CH-22
8	DIGIN CH-23
9	DIGIN CH-24
10	RETURN CH 21-24
20	DIGIN CH-25
21	DIGIN CH-26
22	DIGIN CH-27
23	DIGIN CH-28
24	RETURN CH 25-28
25	DIGIN CH-29
26	DIGIN CH-30
27	DIGIN CH-31
28	DIGIN CH-32
29	RETURN CH 29-32

Table 4-16. DIGIN Pin Connections for SKT-F

Pin	Function
19	DIGIN-CH7
18	DIGIN-CH8
17	RETURN CH5-8
16	DIGIN-CH9
15	DIGIN-CH10
14	DIGIN-CH11
13	DIGIN-CH12
12	RETURN CH9-12
11	DIGIN-CH13
10	DIGIN-CH14
9	DIGIN-CH15
8	DIGIN-CH16
7	RETURN CH13-16

### 4.2.2 Digital Outputs (DIGOUT)

Each Prover module provides 12 digital output (DIGOUT) high current, open collector type channels. The maximum current rating is 100 mAmps at 24 Volts dc. Output frequencies up to 0.5 Hz are possible.

Carefully check the DC polarity. Use an external DC supply in series with the load. When using inductive loads (such as relay coils), place a diode across the load.

The DIGOUT channels CH1 and CH2 are located on connector SKT-E. Channels CH3 and CH12 are located on connector SKT-F. Refer to *Tables 4-17 and 4-18* for the DIGOUT pint connections. Refer to *Figures 4-26 and 4-27* for field schematics.

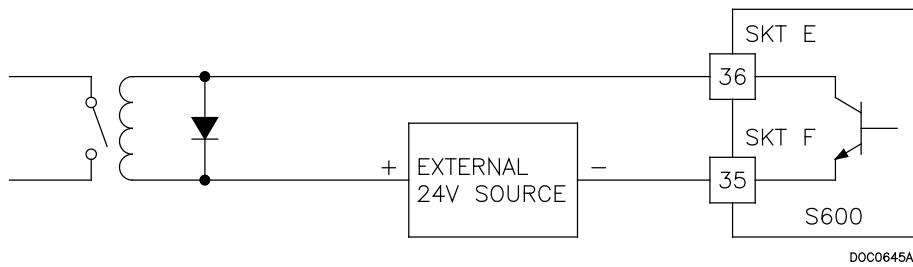

Figure 4-26. Digital Output Schematic (Relay)

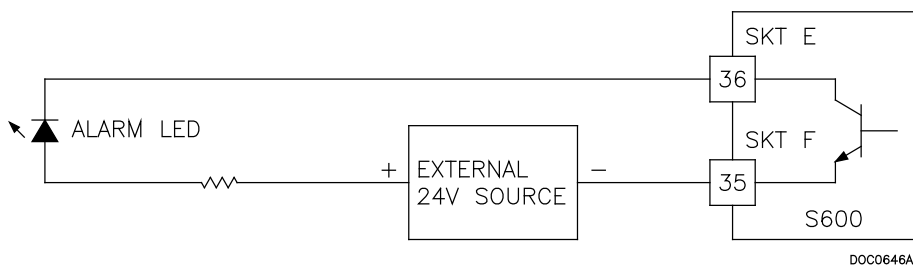

Figure 4-27. Digital Output Schematic (24V Switched Indicator)

Table 4-17. DIGOUT Pin Connections for SKT-E

Pin	Function
36	DIGOUT-CH1
37	DIGOUT-CH2

Table 4-18. DIGOUT Pin Connections for SKT-F

Pin	Function
37	DIGOUT-CH3
36	DIGOUT-CH4
35	RETURN CH1-4
34	DIGOUT-CH5
33	DIGOUT-CH6
32	DIGOUT-CH7
31	DIGOUT-CH8
30	RETURN CH5-8
29	DIGOUT-CH9
28	DIGOUT-CH10
27	DIGOUT-CH11
26	DIGOUT-CH12
25	RETURN CH9-12

### 4.2.3 Turbine Pulse Inputs

You can use the four pulse inputs either independently or as two pairs. Generally, they are used for dual pulse measurement, such as turbine

applications. In dual pulse mode, you can enable level A or B pulse checking.

Each input has an input range of 1 Hz to 10 kHz. Each channel has live integrity checking. If cabling faults develop or if the pre-amp power fails, the system activates a circuit fail alarm.

Table 4-19 shows the dual-pulse input pin connections. Refer to Figure 4-28 for field wiring schematics.

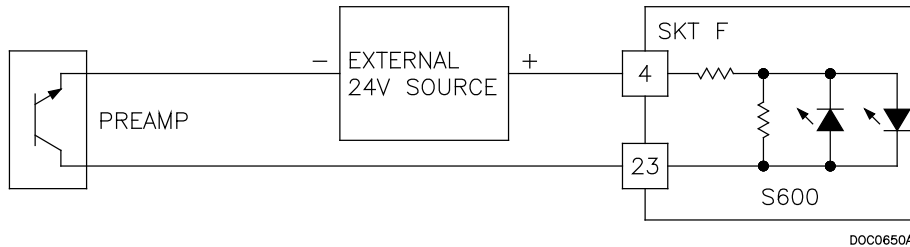

Figure 4-28. Pulse Input Schematic (with 24 V P148 Mezzanine Module)

Table 4-19. Dual-Pulse Input Pin Connections for SKT-F

Pin	Function
4	DUAL PULSE-CH1+
23	DUAL PULSE-CH1-
3	DUAL PULSE-CH2+
22	DUAL PULSE-CH2-
2	DUAL PULSE-CH3+
21	DUAL PULSE-CH3-
1	DUAL PULSE-CH4+
20	DUAL PULSE-CH4-

#### 4.2.4 Pulse Outputs (PULSEOUT)

The S600+ provides four programmable pulse outputs, typically used for electronic counters. Refer to Table 4-20 for the PULSEOUT pin connections. Refer to Figure 4-29 for field wiring schematics.

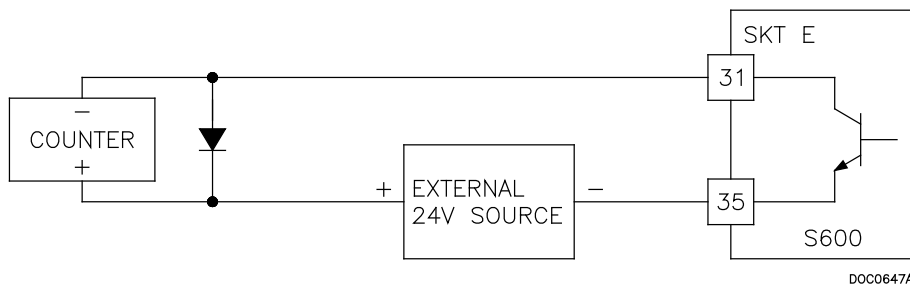

Figure 4-29. Pulse Output Schematic

Table 4-20. PULSEOUT Pin Connections for SKT-E

Pin	Function
31	PULSEOUT-CH1
32	PULSEOUT-CH2
33	PULSEOUT-CH3
34	PULSEOUT-CH4
35	RETURN CH1-4

## 4.2.5 Frequency Inputs

The S600+ supports two frequency inputs, typically used for density transducer signals. Each input has an input range of 0 to 10 KHz.

Table 4-21 shows the frequency input pin connections. Refer to Figures 4-30 and 4-31 for field wiring schematics.

**Note:** The Micro Motion (previously Solartron) devices shown in Figures 4-30 and 4-31 may still have their previous manufacturer's labels.

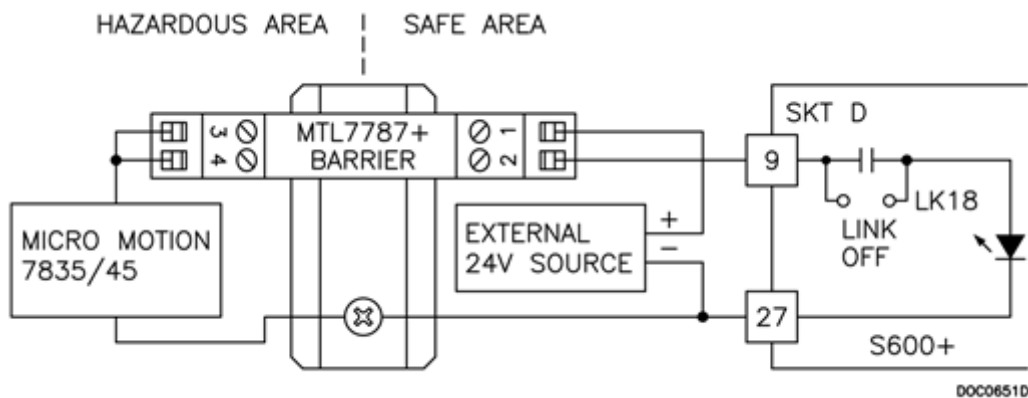

Figure 4-30. Frequency Input Schematic (with IS Barrier and AC-Coupled)

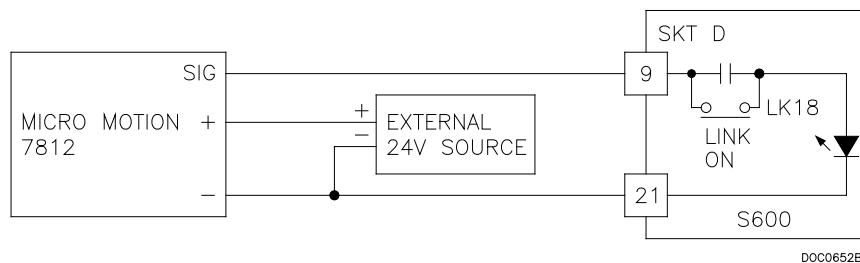

Figure 4-31. Frequency Input Schematic (without IS Barrier and DC-Coupled)

**Note:** The Micro Motion (previously Solartron) devices may still have their previous manufacturer's labels.

Table 4-21. Frequency Input Pin Connections for SKT-D

Pin	Function
9	FREQUENCY-CH1+
21	FREQUENCY-CH1-
10	FREQUENCY-CH2+
22	FREQUENCY-CH2-

## 4.2.6 Raw Pulse Output (RAWOUT)

Section 4.1.7 shows the RAW output from the I/O board. RAW PULSES can be fed into RAW INPUT 1 (pins 1 and 14) or RAW Input 2 (pins 2 and 15) at 24 volts. RAW Input 3 is at TTL level, and you **must** set the links on the I/O board for TTL level if you are using this input. The output is 5 volts and not suitable for long cable runs. The preferred use of this output is for internal raw input only.

## 4.2.7 Jumper Settings

The boldface entries in the Position column on Table 4-22 are the default configuration settings. They may not apply to your specific configuration.

Table 4-22. Prover Module Jumper Settings

Jumper	Position		Descriptions												
<b>Flash</b>															
LK1	ON		Write Enable												
	<b>OFF</b>		Write Protected												
<b>Node Address</b> (see Table 4-23)															
LK2	ON														
	<b>OFF</b>		Multiplexed mode (MUX)												
LK11	ON														
	<b>OFF</b>		Multiplexed mode (MUX)												
<b>MUX Address:</b>	<b>1</b>	<b>2</b>	<b>3</b>	<b>4</b>	<b>5</b>	<b>6</b>	<b>7</b>	<b>8</b>	<b>9</b>	<b>10</b>	<b>11</b>	<b>12</b>	<b>13</b>	<b>14</b>	<b>15</b>
LK3							•								•
LK4						•								•	
LK5					•								•		
LK6				•								•			
LK7			•								•				
LK8		•								•					
LK9	•								•						
LK10	<b>1-2</b>	•	•	•	•	•	•	•							
	<b>2-3</b>								•	•	•	•	•	•	•
<b>Altera Voltage</b>															
LK12	1-2		3.465V												
	<b>2-3</b>		5V - Vcc												
<b>Raw Pulse Output Mode</b> (currently not supported)															
LK13/14	1-2		RS-422 differential driver												
	<b>2-3</b>		Open collector												
<b>Raw Pulse Input #3 – Line Determination</b>															
LK15/16	<b>ON</b>		Line determination resistors connected: +ve pulled up to Vcc and –ve down to 0V												
	<b>OFF</b>		Lines undetermined												

Table 4-23. Node Addressing: Communications Mode Selection

Mode	Link 2	Link 11	Link 3-10
Point-to-point	ON	OFF	IGNORED
Multi-dropped	ON	ON	IGNORED
Multiplexed (MUX)	OFF	OFF	ADDRESS

### 4.3 HART Module (P188)

A 12-channel I/O module provides communications between Highway Addressable Remote Transducer (HART<sup>®</sup>) devices and the S600+. Each digital input channel is capable of handling up to 8 devices (up to a maximum of 50 transmitters for the HART module). The S600+ supports point-to-point, multi-drop, and dual master architectures.

You make connections through two 25-pin D connectors located on the backplate of the HART module. Socket A connects to a 25-pin male connector and socket B connects to a 25-pin female connector. See *Figure 4-32*. *Tables 4-24* and *4-25* provide pin connection information for the two ports (SKT-A and SKT-B) respectively. *Figures 4-33* through *4-35* provide field wiring information.

---

**Note:**

- If you remove and re-attach a HART device to a different channel, you must power cycle the S600+ for the changes to take effect.
  - The FloBoss S600+ is fully compatible with HART 5 devices, and HART 7 devices are backwards compatible with HART 5 devices.
-

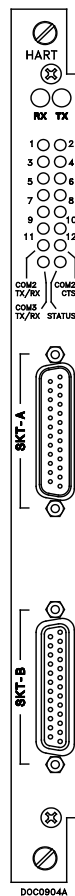

Figure 4-32. HART Module (P188)

Table 4-24. HART Pin Connections (Socket A)

Socket A Channel Number	Socket A Pin Number
Channel 1+	1
Channel 1-	14
Channel 2+	2
Channel 2-	15
Channel 3+	3
Channel 3-	16
Channel 4+	4
Channel 4-	17
Channel 5+	5
Channel 5-	18
Channel 6+	6
Channel 6-	19
Channel 7+	7
Channel 7-	20
Channel 8+	8
Channel 8-	21

Table 4-25. HART Pin Connections (Socket B)

Socket B Channel Number	Socket B Pin Number
Channel 9+	13



Channel 9-	25
Channel 10+	12
Channel 10-	24
Channel 11+	11
Channel 11-	23
Channel 12+	10
Channel 12-	22

**Caution**

Each channel on the HART module requires an external 270Ω (270R) resistor to terminate the HART signal for that channel. If any changes to connections directly to the board are going to be made, then the unit must be powered down to avoid damage to the channel.

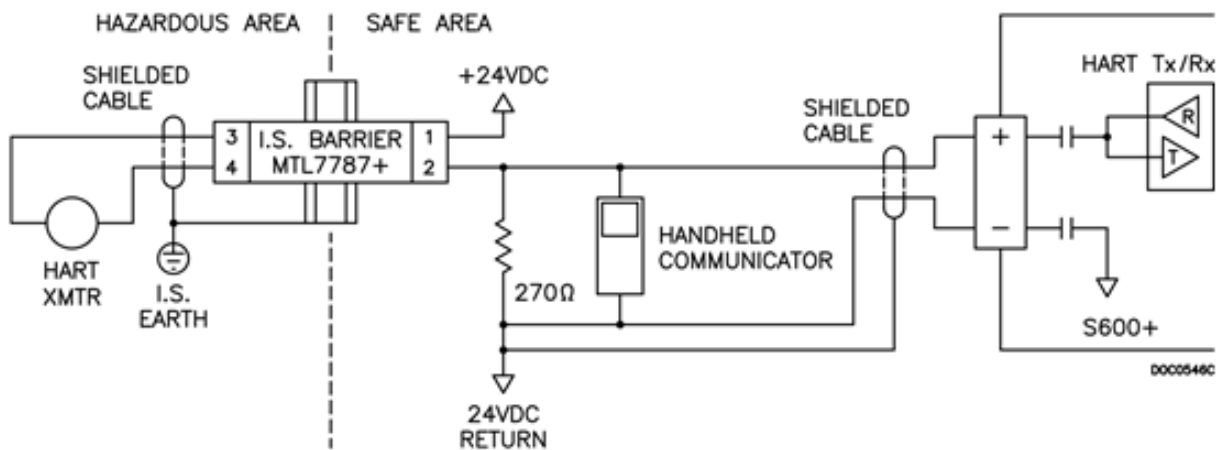

Figure 4-33. HART Device Beyond the IS Barrier

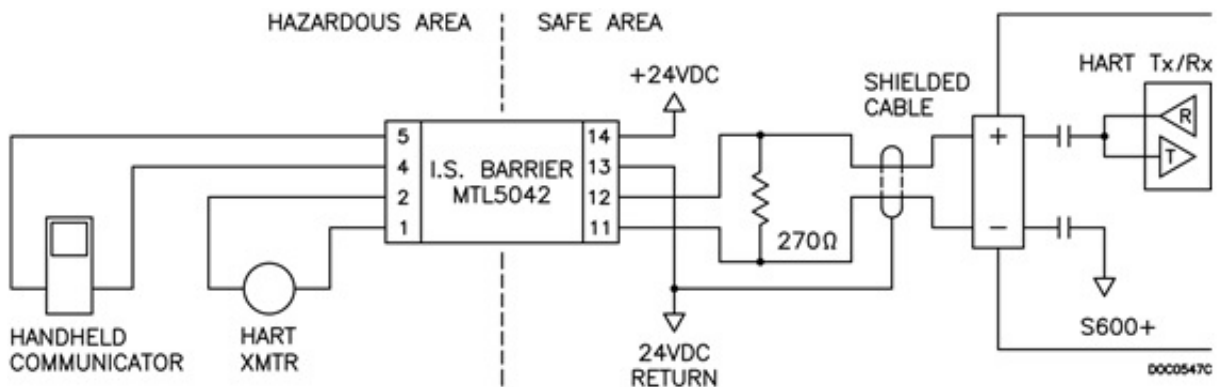

Figure 4-34. HART Device and Handheld Communicator Beyond the IS Barrier

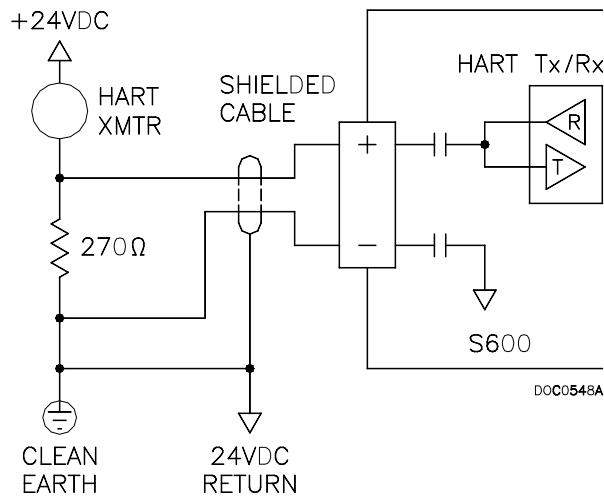

Figure 4-35. HART Device without Handheld Communicator

#### 4.4 Mezzanine Module (P148)

The mezzanine module (P148) provides pulse inputs and is factory installed on both the I/O and prover modules (see *Figure 4-2*). When used on the I/O module, it affects pulses 1 and 4; when used on the Prover module, it affects pulses 2 and 5.

Typically, the mezzanine module supports master meter provers, but can be employed for other provers as well.

## Chapter 5 – Front Panel

### In This Chapter

5.1	Description .....	5-1
5.2	Front Panel Port.....	5-2
5.3	Keypad.....	5-2
5.3.1	Function Keys (F1 - F4).....	5-2
5.3.2	Direction and Menu Keys .....	5-3
5.3.3	Numeric Keys .....	5-3
5.3.4	Operation Keys.....	5-3
5.3.5	Alarm LED and Alarm Keys.....	5-4
5.4	LCD Display .....	5-4
5.5	Navigating the Displays .....	5-6
5.5.1	DISP Key .....	5-8
5.5.2	Moving Through the Menus.....	5-8
5.5.3	Menu Hierarchy .....	5-9
5.5.4	Security Codes .....	5-9
5.6	Changing a Display Option.....	5-9
5.7	Changing a Display Value.....	5-10
5.8	Changing a Calculation Mode .....	5-11
5.9	Assigning a Default Page.....	5-12
5.10	Assigning a Page to a Function (F) Key.....	5-12
5.11	Using the Exponential (EXPT) Key .....	5-12
5.12	Using the Print Key.....	5-13
5.13	Enabling USB .....	5-15
5.14	Exporting Reports (USB).....	5-15
5.15	Selecting a Configuration .....	5-17

This chapter discusses the S600+'s front panel, including the keypad, LCD display screen, communications port, and LED. The chapter also discusses how to navigate through the display screens.

### 5.1 Description

The S600+'s front panel provides a local interface you can use to review or modify the values and statuses of system parameters. *Figure 5-1* shows the layout of the front panel.

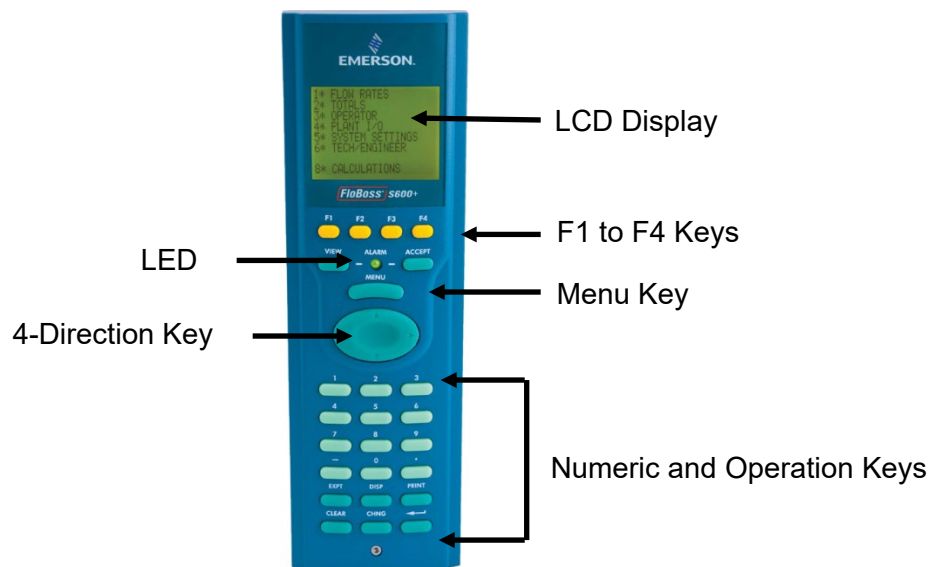

Figure 5-1. Front Panel

## 5.2 Front Panel Port

The front panel port, located on the bottom of the front panel, is the primary connection for the Config600 software program to use when transferring configuration files. The port requires a six-pin RJ-12 connector (part number 3080017) for RS-232 (RS-232D) communications (see *Figure 5-2*).

*Table 5-1* shows the pinout connections for a six-pin connector. You may also want to refer to *Table 3-7* in *Section 3.3.4, Local Operator PC or Remote Display Port*, which describes the pinouts when using the 15-way D-type female connector.

*Table 5-1. Front Panel Port Connections*

Pin	Function
1	RTS
2	TX
3	GND
4	GND
5	RX
6	CTS

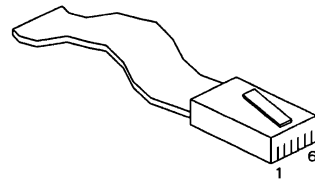

*Figure 5-2. Front Panel Port Connector*

## 5.3 Keypad

The keypad for the front panel has been designed for ease-of-use and to reduce the possibility of error. Keys on the keypad are color-coded by type:

- Yellow: Function.
- Dark green: Four-direction and MENU.
- Light green: Numeric.
- Dark green: Operation

### 5.3.1 Function Keys (F1 - F4)



The top of the keypad has four yellow function keys numbered F1 to F4. You can program each F key as a shortcut to a frequently used display page. Refer to *Section 5.10, Assigning a Page to a Function (F) Key*, for the procedure on programming an F key.

### 5.3.2 Direction and Menu Keys



The large, oval, four-direction arrow key is located just below the MENU key (see *Figure 5-1*). Note the directional arrows ( $\blacktriangle$ ,  $\blacktriangleright$ ,  $\blacktriangledown$ , and  $\blacktriangleleft$ ) in the surface of the four-direction key. Pressing these arrows allows you to navigate the display matrix and select parameters or data items to view or change.

Press **MENU** to return up one level of the display hierarchy. On a data page, pressing **MENU** returns you to the parent menu. On a menu page, pressing  $\blacktriangle$  returns you to the Main menu.

### 5.3.3 Numeric Keys



The numeric keys occupy the lower part of the keypad. They offer the full number set (0-9), a minus key ( $-$ ), and a decimal point ( $.$ ).

- **Numeric 0 to 9:** Used to enter or change data and to navigate the display screens.
- **Minus:** Used to define the default display on the S600+ or to enter negative numbers.

You can also use the minus key to define access shortcuts to frequently used displays. Refer to *Section 5.9* for further information.

### 5.3.4 Operation Keys



You use the Operation keys in conjunction with the numeric keys to perform a variety of tasks, including:

- **Exponent (EXPT):** Use the EXPT key to enter numbers in scientific notation. For example, if the value you need to enter exceeds the space available on the display (a maximum of 20 characters), you need to express the data in exponential terms.
- **CLEAR:** Use the CLEAR key to cancel or exit from the current operation and return to the previous data display. You can also use CLEAR to activate the default display (if configured).
- **Display (DISP):** Use the DISP key to enter the path of a required display. The Status/ID line at the bottom of every data page shows the display path.
- **Change (CHNG):** Use the CHNG key to edit a displayed database item.

---

**Note:** You can only change items marked with an asterisk (\*).

---

- **PRINT:** Use the PRINT key to display the print menu, where you can submit commands for various pre-configured reports or logs to a printer or computer terminal.
- **Enter ( $\leftarrow$ ):** Use this key (called the Enter key in this chapter) in combination with the numeric and CHNG keys to confirm that you have entered the data correctly and completed an operational sequence.

### 5.3.5 Alarm LED and Alarm Keys



Located between the F keys and the **MENU** key on the keypad is the Alarm LED and two alarm-related keys, **VIEW** and **ACCEPT**.

During normal operations (with no alarms activated), the Alarm LED is constantly green. The system can trigger an alarm when there is a malfunction or when measurements exceed the pre-set limits for a parameter.

At that point, the alarm signal may be relayed to a terminal or klaxon in the control room. On the S600+ front panel, a flashing red LED indicates an alarm. The alarm display shows the source of the alarm.

When an alarm activates, the light flashes red until you press **VIEW** to display the parameters that have triggered the alarm. You then press **ACCEPT**. Once you acknowledge an alarm, the LED light is a constant red until you clear all the alarm conditions.

#### Alarm Display



The first line of the alarm display indicates the date and time of the alarm. Until you accept the alarm, the date displays in inverse video (that is, light letters on a dark background). The second and third lines describe where the alarm has been activated and its nature. The total number of alarms (both accepted and unaccepted) appears on the bottom line of the alarm display.

If you have more than one alarm to view, you can press ▲ or ▼ to cycle through the alarm display.

After you have viewed all the alarms, press **ACCEPT**. That notifies the S600+ that you have viewed all the alarms and are prepared to acknowledge them all together. The inverse date on all the alarms then returns to normal video.

Once you clear an alarm condition, its alarm prompt automatically clears from the display. When you have cleared all the alarms in the system, the Alarm light resets to a constant green.

---

**Note:** If the Alarm LED is orange, refer to *Chapter 8, Troubleshooting*.

---

### 5.4 LCD Display



The S600+'s LCD front panel display provides up to eight lines of information displayed as alpha-numeric characters. Displays can be menus (which typically enable you to access sub-menus) or data pages. *Figure 5-3* shows the S600+ main menu:

Asterisk after an option number indicates a sub-menu.

- |    |                 |
|----|-----------------|
| 1* | FLOW RATES      |
| 2* | TOTALS          |
| 3* | OPERATOR        |
| 4* | PLANT I/O       |
| 5* | SYSTEM SETTINGS |

```

6* TECH/ENGINEER
8* CALCULATIONS

```

Figure 5-3. S600+ Main Menu

The S600+ uses all eight lines of the display to show the available menu options, which are arranged in a hierarchy of menus and submenus. Each item on menus and associated submenus is numbered, which enables you to select menu items using the numeric keys on the keypad.

An asterisk (\*) immediately after an option's number (such as 1\* FLOW RATES) indicates that you can access one or more submenus from that option. A decimal point (.) immediately after an option's number (as in 1. STR01 UVOL FR) indicates the option accesses a data page but no submenu.

Generally, each data page shows one or more data item(s) from the S600+ database along with the associated text, units, and description.

**Editable Values** An asterisk can also indicate a value you can edit, depending on your security and the database configuration (see *Figure 5-4*).

An asterisk at the end of a data line indicates a changeable (read/write) data item. Prompts and messages appear when you enter or edit data items. Any data displays without asterisks are read-only.

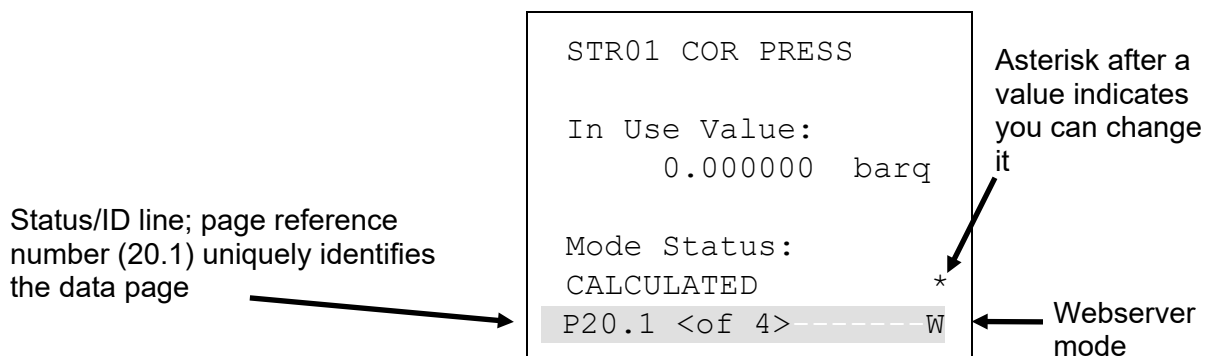

Figure 5-4. Editable Value

**Status/ID Line** The Status/ID line (the shaded line at the bottom of *Figure 5-4*) appears on every data page.

The Status/ID line shows that page's unique page reference number in the configuration (here, **20.1**) and also indicates if other data pages are available for viewing (<of 4>). Use ◀ and ▶ (on the oval direction key) to navigate to those pages.

**Page Reference Number** The page reference number indicates the location of that data display page on the S600+'s display structure for that configuration. One way to understand this display structure is to visualise a table consisting of many rows and many columns. Each data page is one "cell" in that table.

The data page in this location would have the page reference number 3.4 (third row, fourth display)

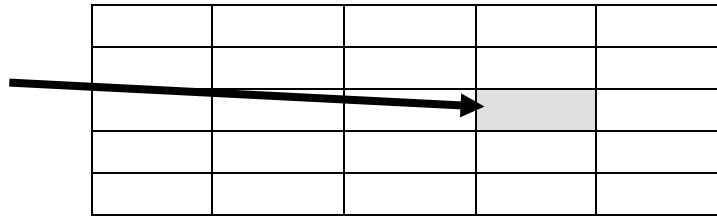

20.1 would then be the first display page on the 20<sup>th</sup> row. You can use the DISP operation key to quickly access that display (see Section 5.5.1. for further information).

**S600+ Mode** A letter may appear at the extreme right of the Status/ID line (see Figure 5-4). It indicates the current mode for the S600+.

Code	Status
P	Prover mode
M	Maintenance mode
S	Standby (peer-to-peer communication link)
D	Duty (peer-to-peer communication link)
W	Webserver (locks out the option to change data at the front panel)

## 5.5 Navigating the Displays

**Note:** The menus, submenus, data pages, and values shown in this section are examples intended **only** to show how the system works. They do not necessarily correspond to menus, data pages, or values on your system.

Figure 5-5 shows a progression from the main S600+ menu to a submenu to a sample data page.

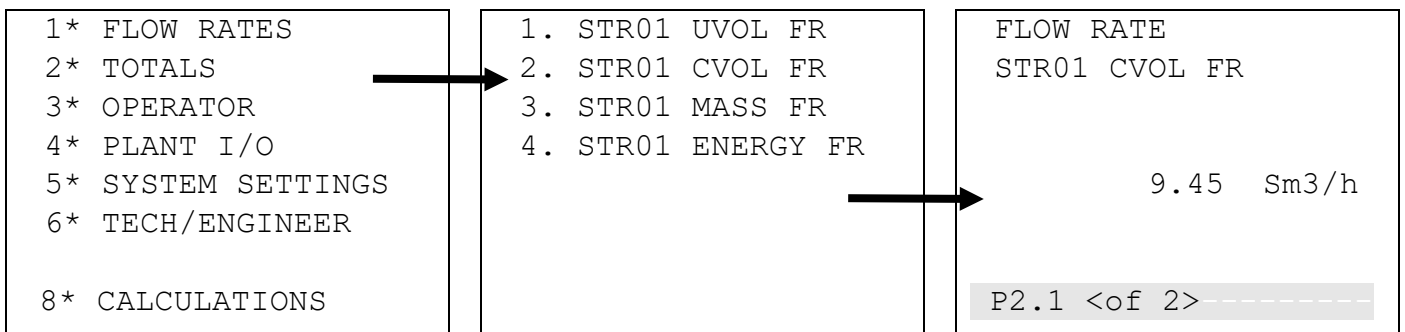
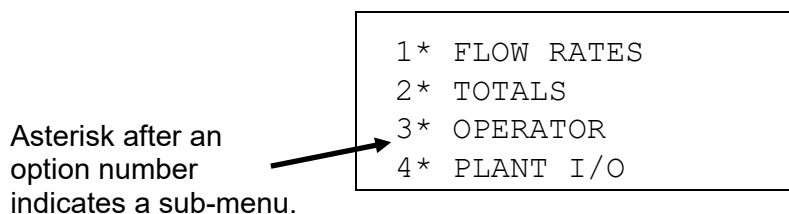

Figure 5-5. Progression of S600+ Menu and Data Page

The S600+ main menu (shown in Figure 5-6) has seven selectable options, indicated by the asterisk (\*) that follows the option number:





```

5* SYSTEM SETTINGS
6* TECH/ENGINEER

8* CALCULATIONS

```

Figure 5-6. S600+ Main Menu

Sub-menus (as shown in *Figure 5-7*) may either have an asterisk or a period after the option number. A period indicates that option accesses a data page.

Period after an option number indicates a display page.

```

1. STR01 UVOL FR
2. STR01 CVOL FR
3. STR01 MASS FR
4. STR01 ENERGY FR

```

Figure 5-7. Submenu

*Figure 5-8* shows a sample data page, which you access through a series of menus. Data pages show system values (here, the current volume flow rate for stream 1). Data pages also have a unique page reference number, shown in the shaded section at the bottom of the page. The shaded area also indicates if other data pages are available to view.

Page reference number

```

FLOW RATE
STR01 CVOL FR

          9.45   Sm3/h

P2.1 <of 2> -----

```

Figure 5-8. Data Display Page



You can move from menu to submenu to data page by pressing the number keys on the keypad. In our example in *Figure 5-5*, pressing **1** followed by **2** takes us to the data page shown in *Figure 5-8*.

Once you have accessed a data page, you can press the oval direction key to display any additional related values. For example, from the data page in *Figure 5-8*, press **▶** to access the second data page in the sequence.

*Figure 5-9* shows that you can press **▼** or **▲** to quickly access adjacent data pages. The data page address changes as you move from page to page.

```

FLOW RATE
STR01 CVOL FR

```

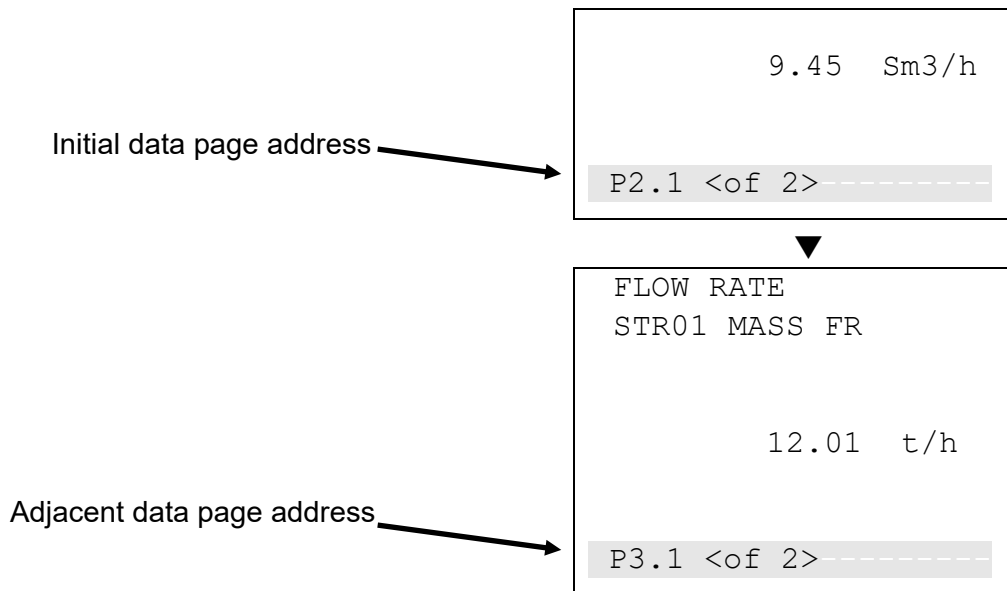

Figure 5-9. Moving between Data Pages

If we relate this action back to our display page table, we can see that these are adjacent screens:

### 5.5.1 DISP Key



Since each data page has a unique page reference number, you can use the DISP key (located on the lower rows of the keypad) and the page reference number to quickly access a specific page.

1. Press **DISP** and a page reference number (such as **25.6**).

**Note:** If you enter only a single number without the decimal (such as **25**), the system displays the **first** page of that row.

2. Press **Enter**. The specified data page displays.

### 5.5.2 Moving Through the Menus

To return to the next-highest level menu, press **MENU**. Repeatedly pressing **MENU** moves you up to the main menu. If you are on a menu or data display page, you can return directly to the main menu at any time (except during an edit sequence) by pressing **MENU** followed by **▲**.

**Note:** If you have pressed **CHNG** and are therefore in an edit sequence, the **MENU** key does not respond until you press

either **CLEAR** (to abort the change) or **Enter** (to complete the change).

### 5.5.3 Menu Hierarchy

Refer to *Appendix B* for information on the menus and sub-menus in the S600+, as well as more information on navigating the front panel display screens.

### 5.5.4 Security Codes

Changing options and display values (as well as some operations at the front panel display) require that you enter a security code. Use the password assigned to you for your access to the S600+.

**Note:**

- Passwords are case-sensitive.
- Valid special characters are: - . / : = @ [ ] ^ \_

Each system user is assigned a security level between 0 (greatest access to system functions) and 9 (least access to system functions). Your security level determines the data you can change. Security level 0 is reserved and cannot be used as a login level for users. To assign or modify security levels, use the Config600 software.

For further information on S600+ security, refer to *Chapter 7, Advanced Setup Configuration* in the *Config600 Pro Software User Manual* (Part D301220X412).

## 5.6 Changing a Display Option

Depending on the security level assigned to your access and the database configuration, you can change the content of some data pages.

You can identify these read/writeable fields by the asterisk at the right edge of the data page and the flashing underline (shown in the left-most page of *Figure 5-10*):

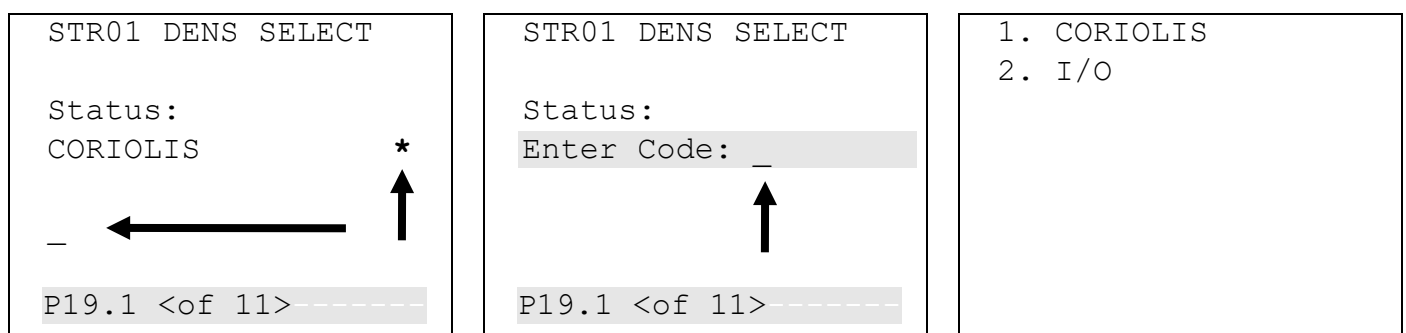
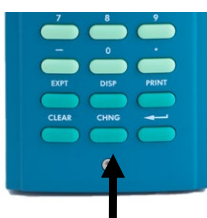

Figure 5-10. Changing a Display Option



To change an option:

1. Locate the display and press **CHNG**. The middle screen (in *Figure 5-10*) displays. S600+ security (which you set using Config600 software) requires you to provide a code to change values.

---

**Note:** If a data page has more than one asterisk, the S600+ highlights the **first** field on the page. Press **▲** or **▼** to move highlighting to the required field.

---

2. Enter a valid security code. Once you enter a valid code, the right-most screen displays, showing available values.
3. Press a numeric key to select a value. The left-hand screen in *Figure 5-11* displays.
4. Press a numeric key to confirm the selected value. The right-hand screen in *Figure 5-11* displays, showing the new value.

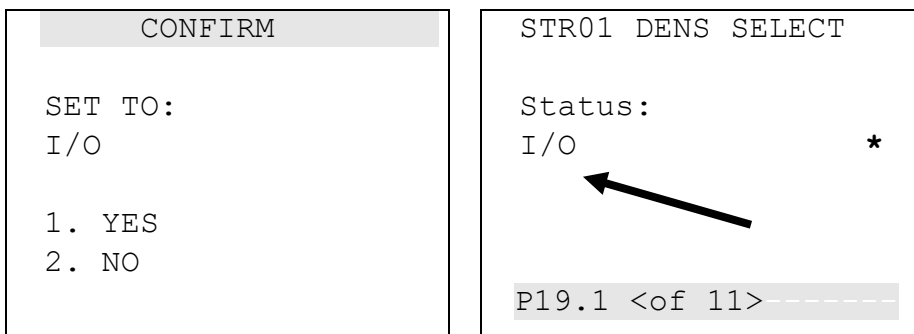

*Figure 5-11. Changing a Display Option*

---

**Note:** This option is not available if the status bar shows **W**, indicating that the webserver is active.

---

## 5.7 Changing a Display Value

You can change the value of any displayed S600+ parameter marked with an asterisk.

To change a value:

1. Locate the display (shown at the left-most side of *Figure 5-12*) and press **CHNG**. The middle screen in *Figure 5-12* displays.
2. Enter a valid security code. Once you enter a valid code, the screen on the right-most side of *Figure 5-12* displays.

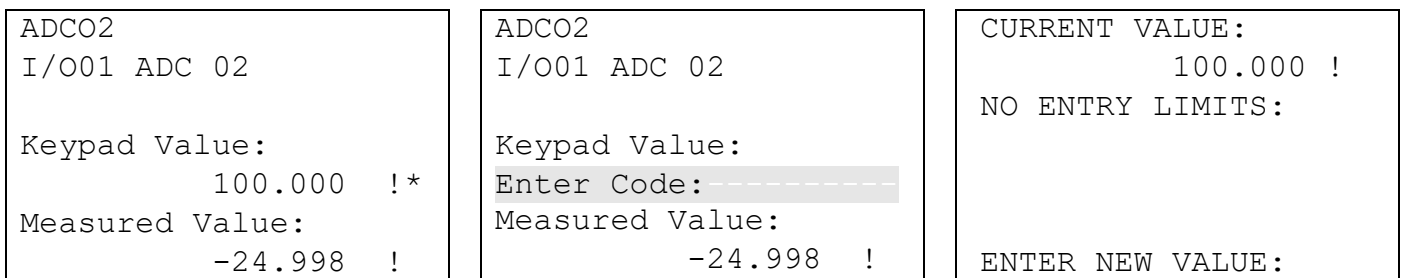

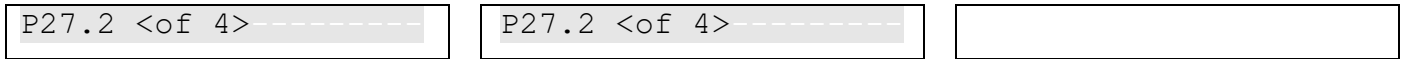

Figure 5-12. Changing a Display Value

3. Enter the new value (in this example, **99.999**). It appears on the display as shown in the left-hand screen of *Figure 5-13*.

---

**Note:** While in Change mode, you can use ◀ to delete digits or characters by backspacing over the displayed data. You can also press **CLEAR** at any time to abort the current operation or task.

---

4. Press Return. The S600+ accepts the new value and displays it as shown on the right-hand screen in *Figure 5-13*.

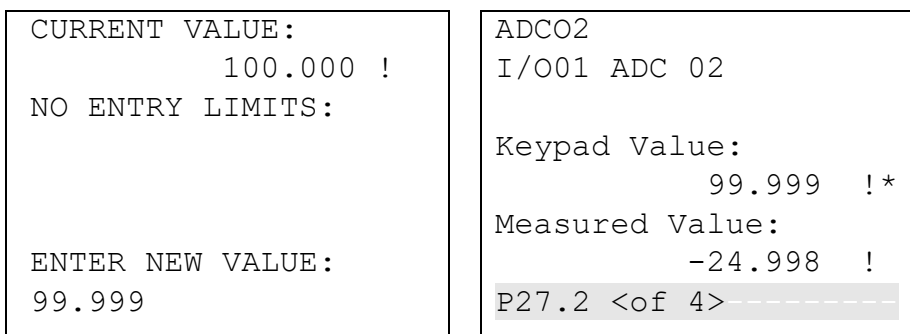

Figure 5-13. Changing a Display Value

## 5.8 Changing a Calculation Mode

The process to change an S600+ calculation mode is similar to changing an option (see *Section 5.6*). The calculation mode selects a new source for a value and switches the value to the field in use. As with values, an asterisk indicates calculation modes you can change.

1. Locate the data page containing the calculation.
2. Press **CHNG** to highlight the field you want to change.

---

**Note:** If a data page has more than one option with an asterisk, the S600+ highlights the **first** field on the page. Press ▲ or ▼ to move highlighting to the required field.

---

3. Press **CHNG**. The security code screen displays.
4. Enter a valid security code.
5. A screen displays a menu of one or more calculations.
6. Select a calculation mode using the appropriate numerical key and press Enter.
7. A Confirm screen displays, showing your new selection. Press **1** to accept or **2** to reject the change. S600+ redisplay the original selection screen showing your change.

---

**Note:** If the data page has only one changeable data item, S600+ automatically exits the edit sequence when you either accept **or** reject the value change.

---

## 5.9 Assigning a Default Page



If you have a specific activity to perform that requires you to temporarily use a particular menu or data display page, use this procedure to set that menu or data display page as the temporary default S600+ display. :

---

**Note:** This process requires you to use the – (“Minus”) key.

---

To define the default display:

1. Go to the required data display page.
2. Press **Minus**.
3. Press **Minus** again to confirm the selection.

To clear the default display, go to a menu page and repeat steps 2 and 3. To invoke the default display, use the **CLEAR** key.

---

**Note:** The **CLEAR** key does not work while in Edit mode.

---

## 5.10 Assigning a Page to a Function (F) Key



You can assign any display page to appear when you press one of the four function keys (F1 through F4). This is helpful when you often need quickly to access a particular page.

1. Access the desired display page.
2. Press the Decimal Point (.) key.
3. Press the F key—F1, F2, F3, or F4—you want to associate with that display page.

---

**Note:** Once you assign an F key to a display page, you cannot undo the assignment unless you clear the SRAM or cold-start the S600+. However, you can always re-assign the F key to a different display page.

---

## 5.11 Using the Exponential (EXPT) Key



The Exponential (**EXPT**) key allows you to enter parameters in scientific notation.

S600+ displays the value in scientific notation if it cannot display the value as a normal number. Using the Config600 software, you can force a data value to always display in scientific notation. For further information, refer either to the *Config600 Software User Manual* (Part D301220X412) or to the online help for the Config600 software.

To enter an exponential value:

1. Key in a value.
2. Press **EXPT** (an E appears on the display) and then enter the required power.
3. Press **Enter**.

For example, to enter the value 0.00000009 as an exponential value, key in **9.0** or **9**, press **EXPT**, enter **8** (to represent the power), and press **Enter** to confirm.

## 5.12 Using the Print Key



By default, the S600+ is configured to output reports to a serial printer or a terminal. The S600+ also outputs reports to its internal webserver (see *Chapter 6, Webserver Access*).

When you press **PRINT**, the Print Options menu displays:

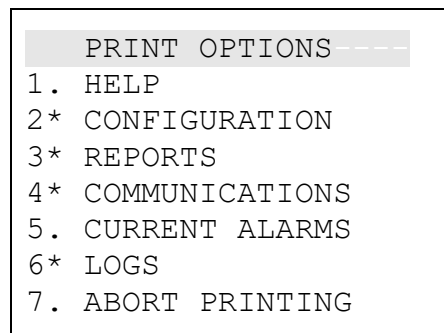

Figure 5-14. Print Options Menu

You use **PRINT** key to generate either a constant log or one of several pre-configured reports. These pre-configured reports include:

**Note:** When requesting report printouts, a five second delay should be observed between print requests to allow the report to be generated.

Report	Description
<b>Constants Log</b>	Lists all the constant parameters and values that are available for change from the display (excluding those on menu 8). <b>Note:</b> You can print the Constants Log as either a text (.TXT) file or with commas separating the items (CSV).
<b>Display Dump</b>	Lists the whole display matrix.
<b>Security Dump</b>	Lists the whole display matrix, along with the current security levels assigned to data items.
<b>All Alarms</b>	Lists all possible alarms that can be generated by the alarm system on this configuration.
<b>Current Report</b>	Lists the current report as configured, normally this would consist of the meter run totals.
<b>Config Report</b>	Lists the configuration-specific parameters, including any configured installed calculation sets.
<b>Archived Reports</b>	Lists all archived reports, sorted by time and date.

<b>Report</b>	<b>Description</b>
<b>Current Alarms</b>	Lists all the acknowledged and un-acknowledged alarms currently set in the flow computer in separate chronological lists.
<b>Modbus Maps</b>	Lists the Modbus maps stored in the S600+ that are assigned to a telemetry link.
<b>Alarm and Event Log</b>	Lists history of all alarms and events.



Select a report based on the following options:

Option	Sub Reports
<b>Configuration</b>	1 Constant Log TXT 2 Constant Log CSV 3 Display Dump 4 Security Dump 5 All Alarms
<b>Reports</b>	1 Current Report 2 Config Report 3 Archived Reports
<b>Communications</b>	1 Modbus Maps
<b>Current Alarms</b>	No sub-options; prints a list of current alarms to the designated terminal or serial printer.
<b>Logs</b>	1 Alarm Log 2 Event Log
<b>Abort Printing</b>	No sub-options; stops printing.

### 5.13 Enabling USB

The enhanced CPU module has a Universal Serial Bus (USB) port that you can use to export reports, alarms, events, and history data to a USB flash drive. The port is disabled (locked) when delivered from the factory.

To unlock the USB port and enable its use:

1. Cold start the S600+.
2. Select **Factory Setup** from the Cold Start menu.
3. Select **USB LOCK**.
4. Select **DISABLE** to unlock the USB port and allow the export of any data to a flash drive.

---

**Note:** The USB port is available after you restart the configuration.

---

### 5.14 Exporting Reports (USB)

The enhanced CPU module has a USB port. You can attach a USB flash drive to the port and use an option on the front panel to export report, event, or alarm history reports to the flash drive.

---

**Note:** This option is also available through the webserver.

---

To export reports:

1. Insert a flash drive in the USB port.
2. Select **TECH/ENGINEER** from the Main Menu.
3. Select **USB** from the Tech/Engineer menu. The USB Report Control menu displays (see the screen sequence in *Figure 5-15*).

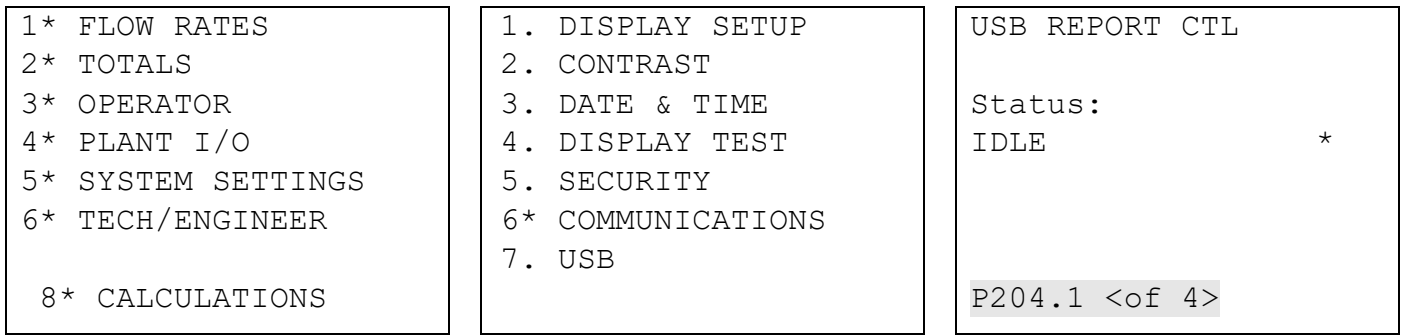

Figure 5-15. USB Report Control Menu

Screens 3 and 4 in the USB report sequence (see Figure 5-16) enable you define how the system presents report content (either as ASCII text or as a CSV file) and whether reports are separate files or combined.

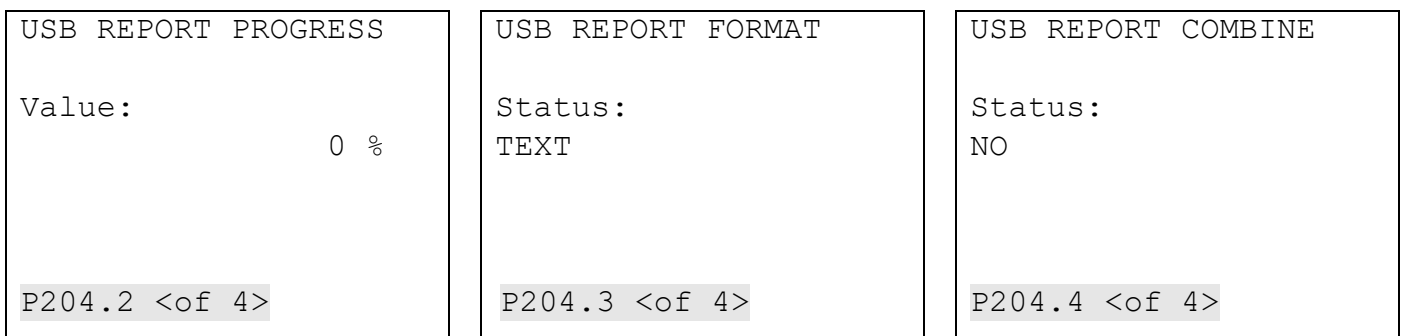

Figure 5-16. USB Report Options

**Note:** Both of these options require you to enter a valid security code before you can change the USB report defaults (text file and separate reports).

- Once you define the report parameters, return to the first screen (USB Report Control) in the sequence.

**Note:** These settings become the defaults for **all** reports you download to the USB flash drive until you change them.

- Press **CHNG**.
- Enter a valid security code. The USB Report Control menu displays.
- Select a report option. A confirmation screen displays.

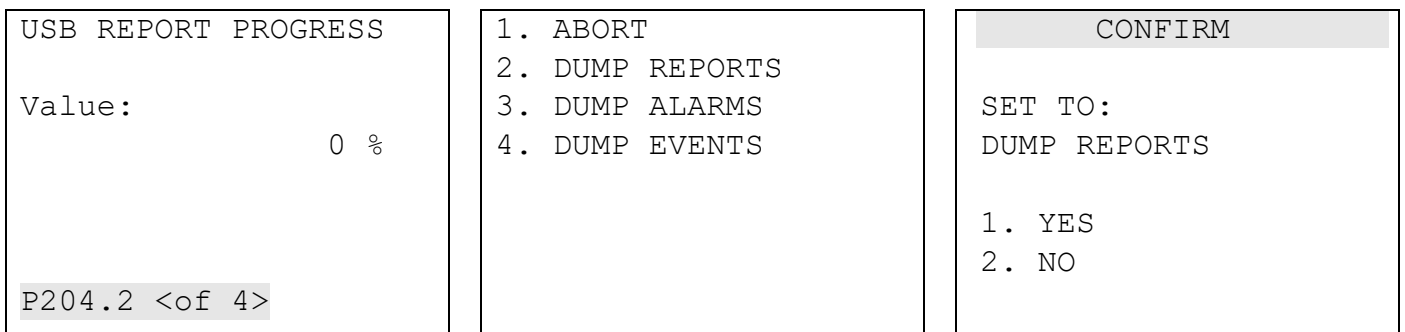

Figure 5-17. Changing a Display Value

- Press **1** to confirm your selection. As the report export proceeds, the USB Report Progress screen shows the percentage of completion.

**Warning**

Removing the USB flash drive while the report dump is in progress may result in file corruption. Remove the flash drive only after the status of the USB Report Control screen returns to IDLE. This may take several minutes.

<pre> USB REPORT PROGRESS  Value:                                 0 %  P204.2 &lt;of 4&gt; </pre>	<pre> USB REPORT CTL  Status: IDLE                                *  P204.1 &lt;of 4&gt; </pre>
---	---

Figure 5-18. Changing a Display Value

- When the report download completes, the USB Report Control screen displays with a Status of IDLE. You can download additional reports or press **Menu** to return to the Tech/Engineer menu.

## 5.15 Selecting a Configuration

The enhanced CPU module enables the S600+ to store up to 20 configurations. By default, the S600+ sets the last configuration downloaded as the active config. However, you can use an option on the front panel to select and activate an alternate configuration.

**Note:** This option is also available through the webserver.

- Access the Cold Start menu and select **Config Selector**. The S600+ displays a series of menus listing all configurations currently loaded (shown in *Figure 5-19*).

<pre> 1* WARM START 2* COLD START 3* NETWORK SETUP 4. REFLASH FIRMWARE 5. CONFIG SELECTOR  8* FACTORY SETUP </pre>	<pre> 1. (1) Serial-1 2. (2) compact_prvr 3. (3) aga8 4. (4) aga3 5. (5) ISO-5167_2003 6. (7) dual_prover 7. (8) bidi-prover 8. Next .. </pre>	<pre> 1. Previous .. 2. (9) compact_prvr 3. (10) aga8 4. (11) aga3 5. (12) empty 6. (13) empty 7. (14) empty 8. Next .. </pre>
--	--	--

Figure 5-19. Selecting a Configuration Menu

- Use the keypad to select a configuration. The Cold Start menu redisplay. Complete the cold start to activate the configuration.

---

**Note:** If you select an option number that is “empty” (does not have an associated configuration), the S600+ ignores the choice and redisplay the Cold Start menu.

---

## Chapter 6 – Webserver Access

### In This Chapter

6.1	Defining Webserver Access.....	6-1
6.2	Accessing the S600+ .....	6-2
6.3	Navigating the Webserver Interface .....	6-4

The S600+ has an embedded webserver, which enables you to access reports, displays, and diagnostics through the Internet. The number of items available for viewing or modification depends on your defined security access level (see *Section 6.1*).



### Caution

Since this access can provide the ability to change critical S600+ settings, reserve webserver access for a corporate TCP/IP rather than general public use.

Using any personal computer (PC) with Internet access and either Microsoft® Edge™ or Windows® Internet Explorer® version 5 or greater (version 9 or greater must use compatibility mode), you can access the S600+ over its Ethernet communications ports. The configuration file residing on the S600+ must have been created using Config600 software version 1.4 (or greater).

### Browsers

For full functionality, Energy and Transportation Solutions recommends you use Microsoft® Edge™ or Windows® Internet Explorer® version 5 or greater (version 9 or greater must use compatibility mode), although alternate web browsers may work.

## 6.1 Defining Webserver Access

Using Config600 software, you must first define the specific content each security level can view.

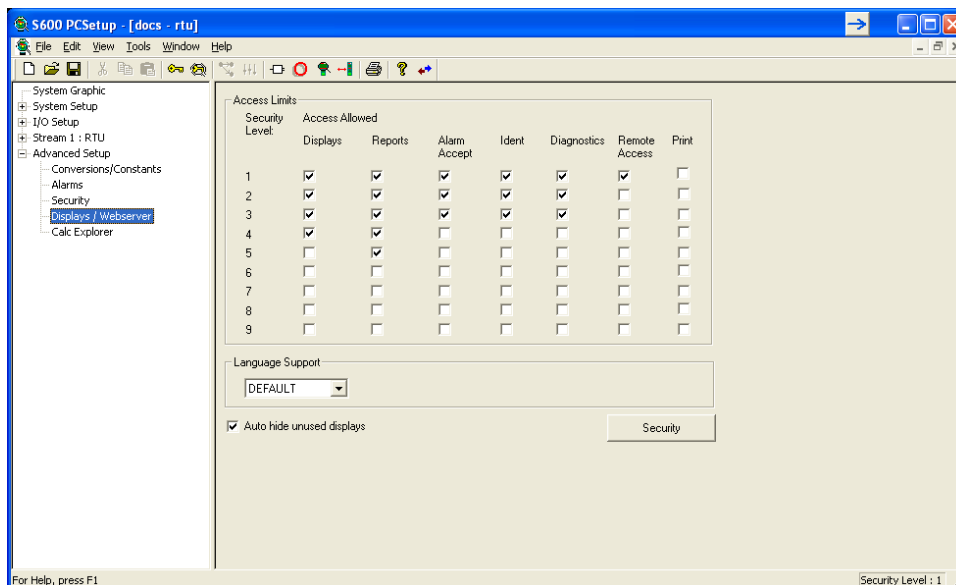

Figure 6-1. PCSetup Webserver Access

For further information on using this screen, refer to *Chapter 7, Advanced Setup Configuration*, in the *Config600 Software User Manual* (part D301220X412).

Once you complete this security level-access matrix, you can access the S600+'s webserver over a TCP/IP connection.

---

**Note:** For firmware prior to version 06.05, webserver access is available **only** through the NTKW1 port on the CPU module. For firmware at or above version 06.05, webserver access is available on **both** the NTKW1 and NTKW2 ports.

---

## 6.2 Accessing the S600+

---

### One Point of Control

While the S600+ web interface can support up to five concurrent webserver sessions, it only allows **one** point of control at a time.

The S600+ gives control—the ability to change data—to the person who **first** accesses the device, whether through the S600+ front panel or through a TCP/IP connection. Anyone else who accesses the S600+, regardless of access method, can only view data until the first user logs off.

Control then passes to the next person with sufficient security who requests that control. Since the S600+ automatically refreshes pages, the page refresh acts as the request for control.



### Caution

**For this reason, ALWAYS use the Log Off option to exit the webserver rather than just closing the browser session. Closing the browser session may not completely relinquish control.**

---

To access the S600+:

1. Connect to the S600+ using the standard communications port.
2. On a PC currently connected to the Internet, open the Microsoft Edge browser.
3. Type the IP address of the S600+ in the browser's URL address bar (in the format *http://nnn.nnn.nnn.nnn*) and press **Enter**.

To obtain the IP address for the S600+'s Ethernet port, use the S600+'s front panel display. From the main menu, select **Tech/Engineer > Communications > Assignment > TCP/IP 1**.

4. S600+ displays a dialog box prompting you for a user name and password (security code).

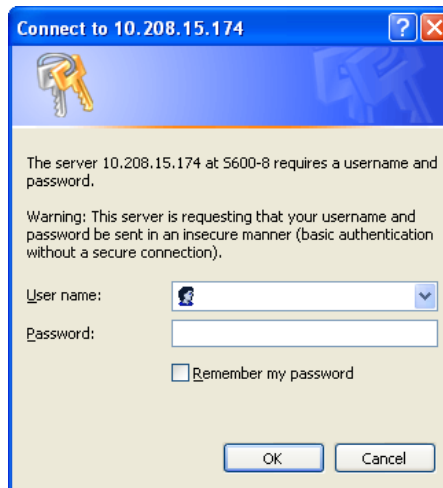

5. Enter the same password that you would use to access the PCSetup Editor. The passwords are established in the configuration. If you are unsure of your user name or password, check with the person who created the configuration for your application.

**Note:** The security level assigned to your security code determines how many menu bar options appear on the web access interface. See *Figure 6-1*.

6. Click **OK**. The browser opens, displaying information from the S600+.

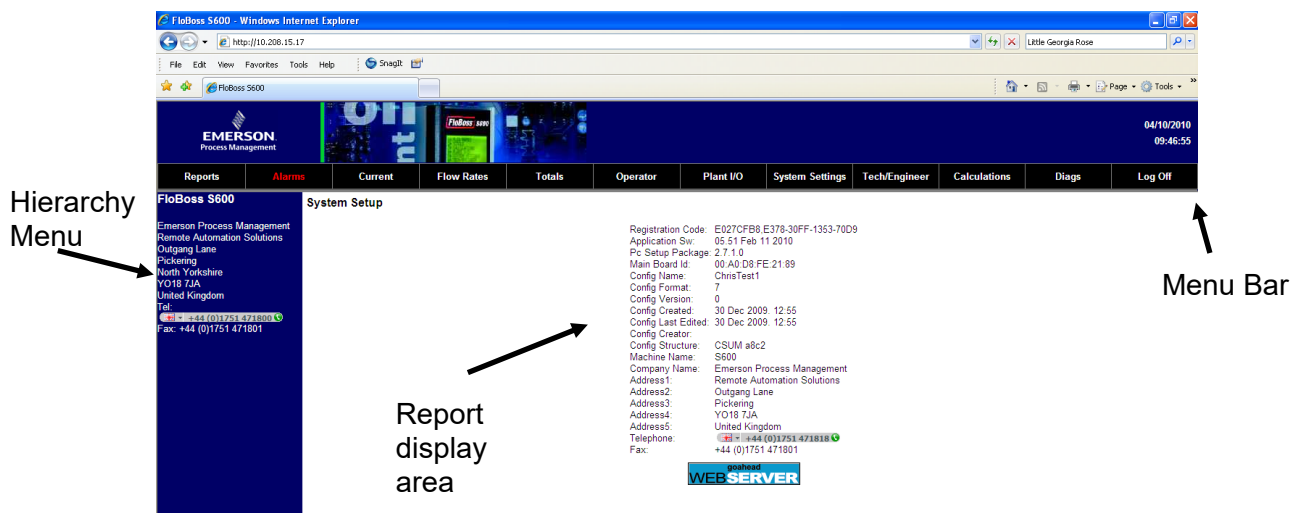

*Figure 6-2. Initial Webserver Access*

You then navigate through the displays using the selections on the screen's menu bar (see *Table 6-1*).

**Note:** The options on the hierarchy menu change as you select options from the menu bar.

Table 6-1. Webserver Menu Bar Options

Option	Description
Reports	Modifies the hierarchy menu to display all available reports.
Alarms	Displays all current alarms in the report display area.
Current	Displays maintenance and current-value reports for each defined stream.
Flow Rates	Modifies the hierarchy menu so you can display flow rates for each defined stream.
Totals	Modifies the hierarchy menu so you can display hourly and daily totals for each defined stream.
Operator	Displays S600+ content as seen by the operator ID.
Plant I/O	Modifies the hierarchy menu so you can display analog and digital inputs and outputs.
System Settings	Accesses various system settings (normally available through the S600+ display panel) through the webserver.
Tech/Engineer	Accesses tech/engineer options (normally available through the S600 display panel) through the webserver.
Calculations	Allows you to review and change various system calculations.
Diags	<p>Displays diagnostic values for streams, stations, and other system settings. Special features include:</p> <ul style="list-style-type: none"> <li>▪ Watch list: enables you to inspect or change database variables. To change variables, enable Debug mode (from Factory Settings on the Cold Start menu).</li> <li>▪ Debug messages: enables you to view advanced debugging information about calculations.</li> <li>▪ Calculation blocks.</li> </ul> <p><b>Note:</b> Enable Debug mode <b>only</b> during development; disable Debug mode when an S600+ is operational at a site.</p>
Log Off	Closes the S600+ webserver session and clears the browser's cache of S600+ information.

### 6.3 Navigating the Webserver Interface

The webserver interface allows you to view reports and data from the front panel display screens. Depending on your security level, you may also be able to change values and navigate through the interface using two navigation bars. Elements of the database display in a menu bar at the top of the screen.

The interface has two basic formats: a data report and a screen format that corresponds to the screens displayed on the S600+ front panel (see *Figures 6-3 and 6-4*).



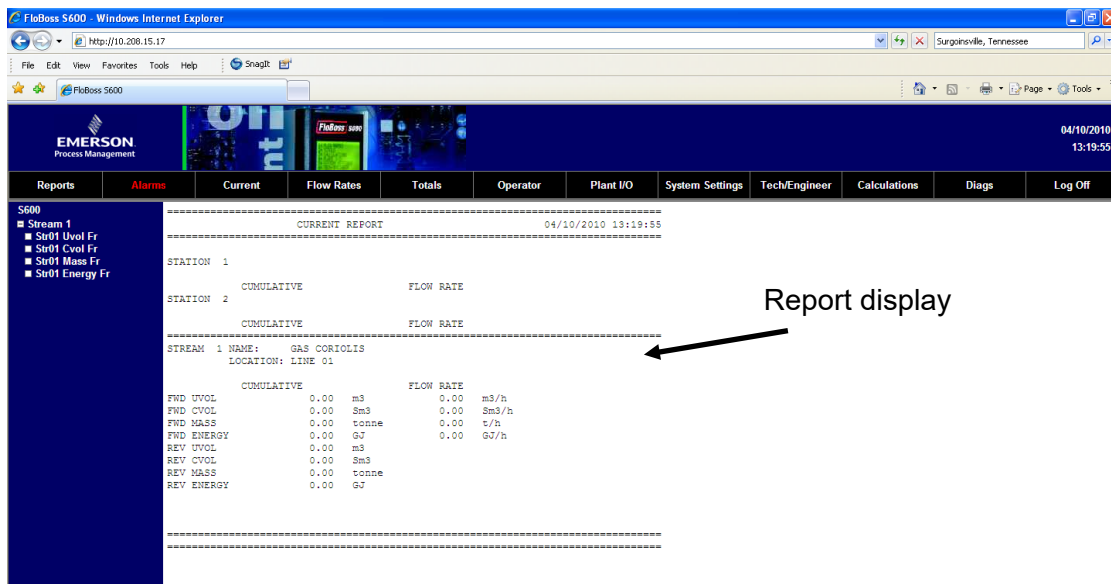

Figure 6-3. Webserver Access (Report Format)

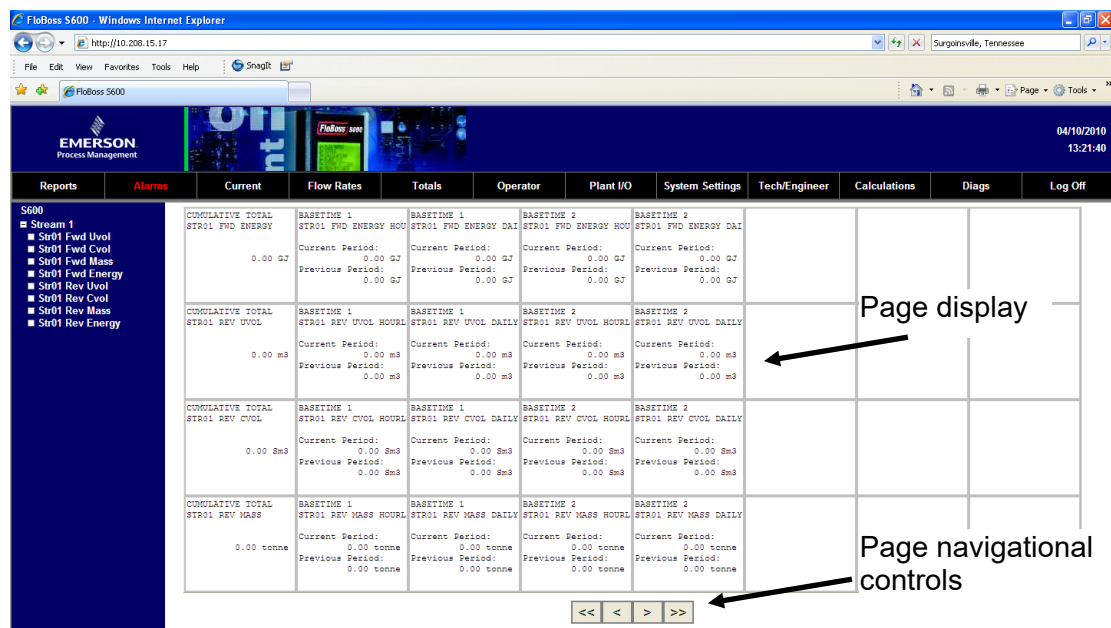

Figure 6-4. Webserver Access (Page Format)

With the screen format, you use the navigational controls at the bottom of the screen to display additional screens.

When you select an option from the menu bar, a hierarchy tree menu appears on the left side of the browser. Use the hierarchy menu to specify the content that appears in the display area.

### CSV Button

The S600+ web interface typically displays content as a text file (as shown in *Figure 6-5*). You may be able to print the screen content using the PRINT button on the menu bar (according to your defined authority).

Alternately, various screens provide a button you can use to create a comma-separated variable (CSV) file you can print or export into a spreadsheet.

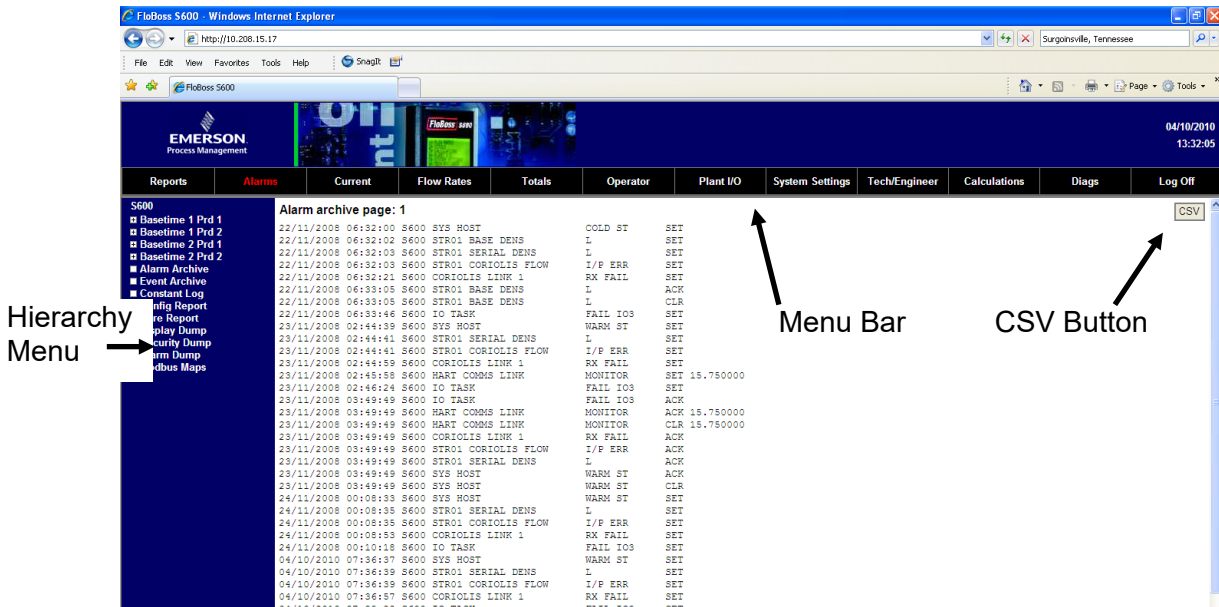

Figure 6-5. Alarm Archive Report

Some screens allow you to interact with the S600+. If the text appears in bold, you can change the data. If the text appears in red, the object is in an alarm state. The system sends any modifications you make to a screen to the S600+ as you make them.

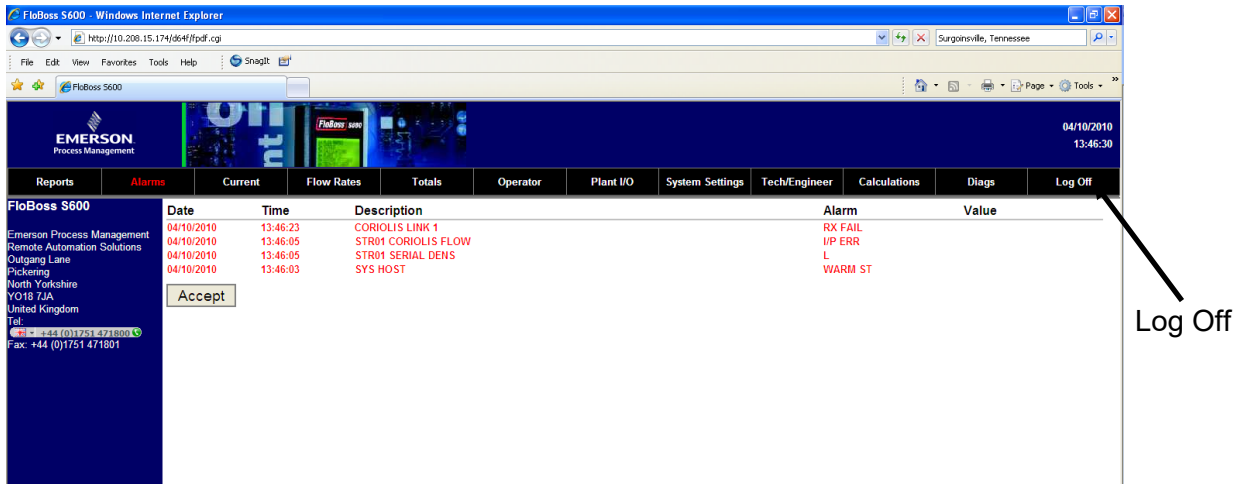

Figure 6-6. Example Alarms Screen

To close a screen, select another element from the menu bar or another screen from the hierarchy menu. To close the webserver access link, select the Log Off option in the menu bar and close the browser.

**Caution**

The caching mechanism on many Internet browser applications may present a security challenge. Remember to log out of your browser session, which clears the browser's cache of S600+ details.

## Chapter 7 – Startup

### In This Chapter

7.1	Starting the S600+ .....	7-1
7.2	Warm Start .....	7-1
7.3	Cold Start .....	7-2
	7.3.1 Initiating a Cold Start .....	7-2
7.4	Startup Menu.....	7-3
	7.4.1 Network Setup .....	7-4
7.5	Messages.....	7-7

This chapter describes procedures for starting and restarting the S600+.

### 7.1 Starting the S600+

After you have wired the S600+ for power and connected it to external devices, you activate it by energizing the external 24 Volts dc power supply. When the S600+ first receives power, it automatically performs an initialization sequence, including a self-test routine. The S600+ displays the message `RESETTING`, and then automatically performs a warm start.

### 7.2 Warm Start

A warm start **does not** affect the configuration memory (SRAM). The S600+ continues operation, using the data stored in the configuration memory just before the restart occurred. It also preserves any current accumulated values.

During a warm start, the S600+ displays the message `RESTARTING`.

Following a successful warm start, the S600+ displays the Main menu, which is the starting point for the display screens. (See the left side of *Figure 7-1*; refer to *Chapter 5, Front Panel*, for more information on navigating the display screens.)

If the S600+ cannot find a valid configuration, it does not perform a warm start. Instead, it displays the Startup menu. (See the right side of *Figure 7-1* and refer to *Section 7.3, Cold Start*, for details.)

1* FLOW RATES	1* WARM START
2* TOTALS	2* COLD START
3* OPERATOR	3* OPERATOR
4* PLANT I/O	4. NETWORK SETUP
5* SYSTEM SETTINGS	5. CONFIG SELECTION
6* TECH/ENGINEER	
8* CALCULATIONS	8* FACTORY SETUP

*Figure 7-1. Main Menu and Startup Menu*

## 7.3 Cold Start

During a **cold start**, the S600+ copies the configuration file from flash memory and replaces any online changes that have been made to the configuration files either since the last ones downloaded from a PC running Config600 software or since the last backup. During a cold start, you have the option of keeping or resetting the cumulative totals. You can only keep totals if the structure of the database has not been changed.

Use a cold start after you send a new configuration to the S600+ or to recover from extreme situations, such as a corrupted database. A cold start builds a new metering database, using the configuration data stored in the S600+'s flash memory.

---

**Note:** You **must** perform a cold start if you update or otherwise change the firmware.

---

### 7.3.1 Initiating a Cold Start

You initiate a cold start using either of two methods:

- Unpowered.
- Powered with operating S600+.

#### Unpowered Cold Start

If the S600+ is **not** powered up, you may set bit link **P2** on the CPU module to the closed (cold start) position and then apply power to the S600+. This displays the Startup menu.

---

#### Caution

**Exercise caution if you set the jumper. When you set the cold start jumper, remember that the S600+ also uses this setting if it self-starts for any reason, such as a low-voltage shutdown or recovery from a malfunction. Remove the cold start jumper setting when you do not need it. Otherwise, an unplanned restart could result in lost data.**

---

1. Select **COLD START** from the Startup menu (see *Figure 7-1*).
2. Press **1** (to keep) or **2** (to reset) the totals.
3. Press **1** to confirm the selection. The S600+ displays the message CONFIGURING – PLEASE WAIT.

The S600+ builds a new database using the configuration files held in flash memory. When completed, the S600+ Main menu displays.

#### Powered Cold Start

If the S600+ is currently running, you must first set the run mode to Cold Start.

---

**Note:** The key sequence you use to access the System Status page may vary, based on the displays for your application.

---

1. From the S600+ Startup menu, select **SYSTEM SETTINGS**.
2. Select **SYSTEM STATUS**.
3. Press **CHNG**.

4. Key in your security code when the `Enter Code` prompt displays.
5. Press **1** to select **COLD ST**, and press **1** again to confirm the selection. The S600+ displays a `SYSTEM RESTARTING - PLEASE WAIT` message.

The S600+ then performs a reset, which concludes when the Startup menu appears.

---

**Note:** If the display has not changed after 30 seconds, power down the S600+, wait at least five seconds, and then re-apply power.

---

6. Select **COLD START** from the Startup menu.
7. Press **1** (to keep) or **2** (to reset) the totals.
8. Press **1** to confirm the selection. The S600+ displays the message `CONFIGURING - PLEASE WAIT`.

The S600+ builds a new database using the configuration files held in flash memory. When it completes, the S600+ Main menu displays.

## 7.4 Startup Menu

---

If the S600+ completes its start-up initialization sequence but does not automatically warm start, the S600+ Startup menu displays (see *Figure 7-1*).

---

**Note:** After you modify any data in the startup menu, the S600+ may require a power cycle.

---

```

1* WARM START
2* COLD START
3* NETWORK SETUP
4. REFLASH FIRMWARE
5. CONFIG SELECTION

8* FACTORY SETUP

```

*Figure 7-2. Startup Menu*

Startup menu options include:

Option	Description
Warm Start	Restarts a previously configured S600+ at the point prior to being powered down.
Cold Start	Builds a new metering database on the S600+ using the configuration files stored in Flash memory.
Network Setup	Configures the TCP/IP, Gateway, and Modbus addresses (see <i>Section 7.4.1, Network Setup</i> ).

Option	Description
Reflash Firmware	Reprograms the S600+ operating system firmware stored in Flash memory (see <i>Chapter 8, Troubleshooting</i> ).
Factory Setup	Clears SRAM and formats Flash memory and changes additional settings. <b>Note:</b> Use this option <b>only</b> at the direction of a factory representative.

## 7.4.1 Network Setup

This option on the Startup menu enables you to define the TCP/IP Ethernet, Gateway, and Modbus network addresses.

**Note:** Determine the necessary network settings **before** you initiate any network communications. You can **only** view or modify these settings physically through the Startup menu. (You **cannot** use the Config600 software to define communications.) The S600+ keeps these settings in a separate area of the SRAM database and retains them after you download a configuration file to the S600+.

**Ethernet LAN** Before you establish an Ethernet LAN connection (for host communications, local operator communications, or web server access), you must verify or define the TCP/IP address.

**Note:** This process requires that you first access the Startup menu

To define the Ethernet LAN network address:

1. Select **NETWORK SETUP** from the Startup menu. The Network Setup menu displays:

```

1* NETWORK 1 I/F
2* NETWORK 2 I/F

4. MODBUS ADDRESS
5. PC SETUP COMMS
6. WEBSERVER SETUP
7. GO BACK

```

*Figure 7-3. Network Startup Menu*

2. Select either **NETWORK I/F 1** or **NETWORK I/F 2**. A connection-specific menu displays:

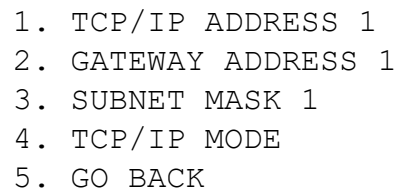
- 
1. TCP/IP ADDRESS 1
  2. GATEWAY ADDRESS 1
  3. SUBNET MASK 1
  4. TCP/IP MODE
  5. GO BACK

*Figure 7-4. Network Definition Menu*

3. Select **TCP/IP ADDRESS 1**. The system prompts you to enter a valid TCP/IP address.
4. Enter an address and press **Enter**.

---

**Note:** If the TCP/IP, gateway address, or subnet mask values are correct, press **CLEAR** to accept the displayed value and return to the Network Definition menu.

---

5. Select **GATEWAY ADDRESS 1**. The system prompts you to enter a valid gateway address.
6. Enter an address and press **Enter**.
7. Select **SUBNET MASK 1**. The system prompts you to enter a valid subnet mask.
8. Enter a valid subnet mask and press **Enter**.
9. Press **4**, then **6** to return to the Startup menu.

#### **Modbus Address**

If you specify a zero address for a Modbus slave configuration, the S600+ configures the Modbus port using the address you enter here. This is helpful when you load the same configuration file into multiple S600+s on the same Modbus address: each S600+ then has a unique node address.

To define the Modbus network address:

1. Select **NETWORK SETUP** from the Startup menu.
2. Select **MODBUS ADDRESS**. The Modbus Address screen displays:

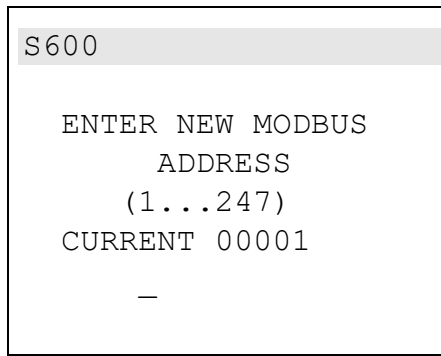

Figure 7-5. Modbus Screen

3. Enter the address value (any value between 1 and 247). If you change the Modbus address, you must restart the S600+ in order for the change to take place.

**PC Comms** Use this option to define serial port connection characteristics

---

**Note:** If you are using an Ethernet connection, you **do not** need to modify these settings.

---

To define the Modbus network addresses:

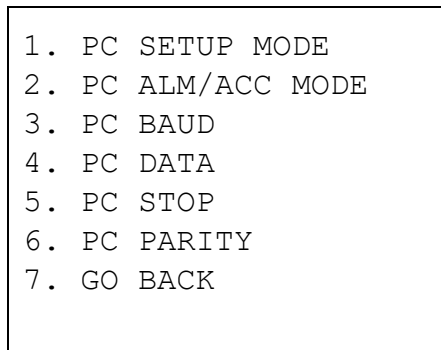

Figure 7-6. Modbus Screen

Menu options include:

Option	Description
PC Setup Mode	Sets the byte count for PC communications. Valid values are 8-bit and 16-bit.
PC ALM/ACC Mode	Sets the ACC alarm. Valid values are Enabled and Disabled.
PC Baud	Sets port baud rate. Valid values are 2400 bps to 57600 bps.
PC Data	Sets the bit count. Valid values are 7 and 8.
PC Stop	Sets the stop bits. Valid values are 1 and 2.
PC Parity	Sets parity. Valid values are 0 (No), 1 (Odd), and 2 (Even).
Go Back	Returns to the Network Definition menu.



## 7.5 Messages

During warm or cold starts the S600+ can display various messages. These include:

Message	Meaning
REFLASH DISABLED	Firmware write protect is enabled. <b>To resolve:</b> From the Cold Start menu, select <b>FACTORY SETUP &gt; FIRMWARE LOCK</b> . You can then disable the firmware write protect.
INCOMPATIBLE PC SETUP VERSION	The configuration file has been edited using a version of Config600 that is incompatible with the version of firmware on the S600+. <b>To resolve:</b> Identify and record the version of software running on the S600+ and the version of Config 600. Contact your support centre for further directions.
NUMBER OF TOTALS DOES NOT MATCH	You have initiated an S600+ cold start with a new config file that elects to keep totals. <b>To resolve:</b> Cold start the S600+ and select RESET TOTALS.
CONFIGURATION CHECKSUM ERROR!	Cold start has failed due to an invalid checksum. <b>To resolve:</b> Re-download the config file. If the problem persists, contact your support centre for further directions.
WARNING - FLASH FILE SYSTEM CORRUPT.	Flash file system has failed. <b>To resolve:</b> Cold start the S600+ and select an S600+ cold start.
CONFIGURING	S600+ is attempting a cold or warm start.
PLEASE WAIT.	
INSUFFICIENT MEMORY	Cannot complete a cold start due to insufficient S600+ memory. <b>To resolve:</b> Reduce the report/alarm/event history.
HARDWARE DOES NOT SUPPORT MULTI-STREAM APPLICATIONS	This S600+ supports only a single stream. <b>To resolve:</b> Contact your support centre for further directions.
REPORT CONFIG HAS CHANGED	This normally occurs when the report layout has been changed. <b>To resolve:</b> Initiate a cold start on the S600+ or download the original config (prior to report changes).
COLD START REQUIRED	
ERROR LOADING REPORT TEMPLATES	S600+ has encountered an error when reading the report templates. <b>To resolve:</b> Check reports for errors. If you don't find errors, contact your service centre.

<b>Message</b>	<b>Meaning</b>
SYSTEM IS BEING CONFIGURED EXTERNALLY	A configuration file is being downloaded to the S600+.
PLEASE WAIT.	
SYSTEM RESTARTING	A reboot is in progress.
PLEASE WAIT.	

## Chapter 8 – Troubleshooting

### In This Chapter

8.1	Guidelines .....	8-1
8.2	Checklists .....	8-2
8.2.1	Power Issues.....	8-2
8.2.2	Startup Menu.....	8-2
8.2.3	Front Panel Lighting .....	8-2
8.2.4	Front Panel LED.....	8-2
8.2.5	I/O LED .....	8-3
8.2.6	I/O Fail Messages .....	8-3
8.2.7	Serial Communications .....	8-3
8.3	Procedures .....	8-3
8.3.1	Reflash Firmware.....	8-4
8.3.2	Send and Reflash the Config File .....	8-4
8.3.3	Clear SRAM .....	8-5
8.3.4	Changing the Fuse.....	8-6

This chapter provides instructions for maintaining and troubleshooting the S600+. If you still experience difficulties after using the troubleshooting procedures in this section, please contact your local sales representative or technical support personnel.

### 8.1 Guidelines

When attempting to diagnose a problem with an S600+:

- Remember to write down what steps you have taken.
- Note the order in which you remove components.
- Note the orientation of the components before you modify or remove them.
- Read and follow all cautions in this manual.

Before you contact your local sales representative or technical support with a problem, first check the following:

- Are all the modules seated correctly and the retaining screws fastened?
- Is all the field wiring properly connected?
- Is the supply voltage correct?

When you are done troubleshooting, perform a warm start or cold start (see *Chapter 7, Startup*).

If your local sales representative or technical support instructs you to return the S600+, replace the troubled parts with spares and return the troubled parts to the address given by the local sales representative or technical support.

## 8.2 Checklists

---

This section provides a series of checkpoints for frequent issues.

### 8.2.1 Power Issues

If you are experiencing trouble with **powering up** the S600+:

- Check the wiring connections at terminal block TB1 on the CPU backplate and the wiring at the power source.
- Check the power supply voltage.
- Check the fuse on the CPU module. Refer to *Section 8.3.4, Changing the Fuse*.

### 8.2.2 Startup Menu

If **RESETTING**, **RESTARTING**, or the Startup menu does not appear on the display:

- Check the power supply voltage.
- Check the fuse on the CPU module. Refer to *Section 8.3.4, Changing the Fuse*.

After initialization, if the Startup menu appears instead of the Main menu, select the Warm Start option. If a warm start does not occur:

- Check jumper J2 on the CPU module. If it is in the closed (cold start) position, then move it into the open (warm start) position to allow a warm start. This also allows the unit to bypass the Startup menu in the future.
- Check for a valid configuration. If no configuration is present, refer to *Section 8.3.2, Send and Reflash Config File*.
- Check whether a Clear SRAM command has been issued.

### 8.2.3 Front Panel Lighting

If the Front Panel display is not backlit:

- Check connector (J2) between front panel and main board.
- Check the display for text and numbers. If the screen is entirely blank, contact your local sales representative or technical support.

### 8.2.4 Front Panel LED

If the LED on the front panel indicates alarm and malfunction states:

- If the LED is green, then the S600+ is functioning correctly.
- If the LED is red, an alarm state exists. Refer to *Section 5.4, Alarm LED and Alarm Keys*, for more information on alarms.
- If the LED is orange, power down the S600+, remove and reseal the boards, and then re-apply power to the S600+.

**Note:** The LED is orange while at the Startup menu. If it is still orange when the configuration is running, contact your local sales representative or technical support.

---

### 8.2.5 I/O LED

If the red or green LEDs on the backplate of the I/O module do not blink while the S600+ is operating:

- Check the I/O module connections. Power down, remove and reseat the I/O module, and then re-apply power.
- Check the front panel display and LED. If they are not lit, you may have a power issue.
- Check with the person who configured the unit whether you have the correct I/O module fitted.
- Check the running configuration for any BAD TX or BAD RX messages. From the Main menu, select **TECH/ENGINEER > COMMUNICATIONS > SERIAL PORTS > PORT 08**.

### 8.2.6 I/O Fail Messages

If the front panel displays an I/O Fail message:

- Check the jumper settings on the I/O modules.
- Check the I/O field wiring connections.
- Check that the I/O modules are seated and secured.

### 8.2.7 Serial Communications

If you are experiencing troubles with a serial communications connection (RS-232, RS-422, or RS-485):

- Check to make sure power is applied to the S600+.
- Check the wiring to the termination block or connector. Refer to *Chapter 3, CPU*.
- Check the communication port settings from the front panel display.
- Check the Modbus address.
- Check the setting of the termination resistor jumper.

## 8.3 Procedures

---

Initiate a cold start after you send a new configuration to the S600+ or to recover from extreme situations, such as a corrupted database. A cold start builds a new metering database, using the configuration data stored in the S600+'s flash memory.

**Note:** You **must** perform a cold start if you update or otherwise change the firmware.

---

### 8.3.1 Reflash Firmware

Using this procedure, you can reprogram the S600+'s flash memory with new values for the operating system components and the application firmware.

**Caution**

Under **no** circumstances should you turn off the S600+ while it is erasing or reprogramming the Flash memory. **Doing so renders the S600+ unusable.**

If this occurs, you must reload the configuration files and the correct version of the operating system's binary files.

---

To reprogram the flash memory:

1. Access the Startup menu on the front panel of the S600+ (refer to *Section 7.3.1*).
2. Select **REFLASH FIRMWARE** from the Startup menu.
3. Press **1** to confirm the selection. The following message displays:  

```
PERFORM CONFIG 600 FLASH COMMAND NOW
```
4. Access the Config Transfer program in the Config600 software, select the required operating system .bin file, and click **Send Now** to download it to the S600+.

---

**Note:** If you are unsure of the version required, consult with the supplier who created your application.

---

5. The following message displays on the front panel:

```
RECEIVING BINARY FILE
```

Once the S600+ has successfully downloaded the file, the following message displays on the front panel:

```
RECEIVED OK
```

---

**Note:** **Do not proceed** if the front panel displays the message `FLASH FAILED`. Remove the power connector for 5 seconds and re-apply power. The S600+ redisplay the startup menu. Begin again at step 1.

---

6. The S600+ then erases and reprograms the flash memory and displays the message:

```
RESETTING - PLEASE WAIT
```

7. The S600+ then restarts. If the S600+ has **not** restarted after 30 seconds, remove the power connector, wait 5 seconds, and replace the power connector. This returns you to the startup menu. Begin again at step 1.

### 8.3.2 Send and Reflash the Config File

Using this procedure, you can download a new configuration file to the S600+ and reprogram the S600+'s flash memory with those new values.

To reflash the configuration data file:

1. Select **Transfer Data** from the Config600 software.
2. Choose the Comm port connected to the S600+. Default parameters for serial ports are 38400 bps, 8 data bits, 1 stop bit, and no parity.

---

**Note:** You can also transfer configuration files using the Ethernet connection, as well as the serial communications port.

---

3. Select the required configuration file and the sections you want to transfer to the S600+.
4. Click **Send Now** to download the file to the S600+.

Once the download completes, the S600+ restarts and displays the Startup menu.

### 8.3.3 Clear SRAM

The Factory Setup option on the Startup menu includes **Clear SRAM** and **Format Flash** options. Use these options only under instruction from factory personnel in the event of a problem.

Use **Clear SRAM** to overwrite the S600+'s SRAM area. With this option, you lose all battery-backed configuration data, including system configuration data, process configuration data, metering totalisers, and network settings.

Following a **Clear SRAM** command, the S600+ restarts and redisplay the Startup menu. You cannot warm start the S600+ again until you download a full configuration from a PC running Config600 software.

To clear SRAM:

1. Select **FACTORY SETUP** from the Startup menu.
2. Select **CLEAR SRAM**.
3. Press **1** to confirm the selection. The following message displays:

COMMUNICATIONS LINK FAILURE

4. Wait 30 seconds. If the display has not changed after 30 seconds, reboot the S600+ (power down, wait five seconds, and then repower). The Startup menu displays when the process completes.

### 8.3.4 Changing the Fuse

The fuse is located in a clip-in type holder on the CPU module (see *Figure 8-1*):

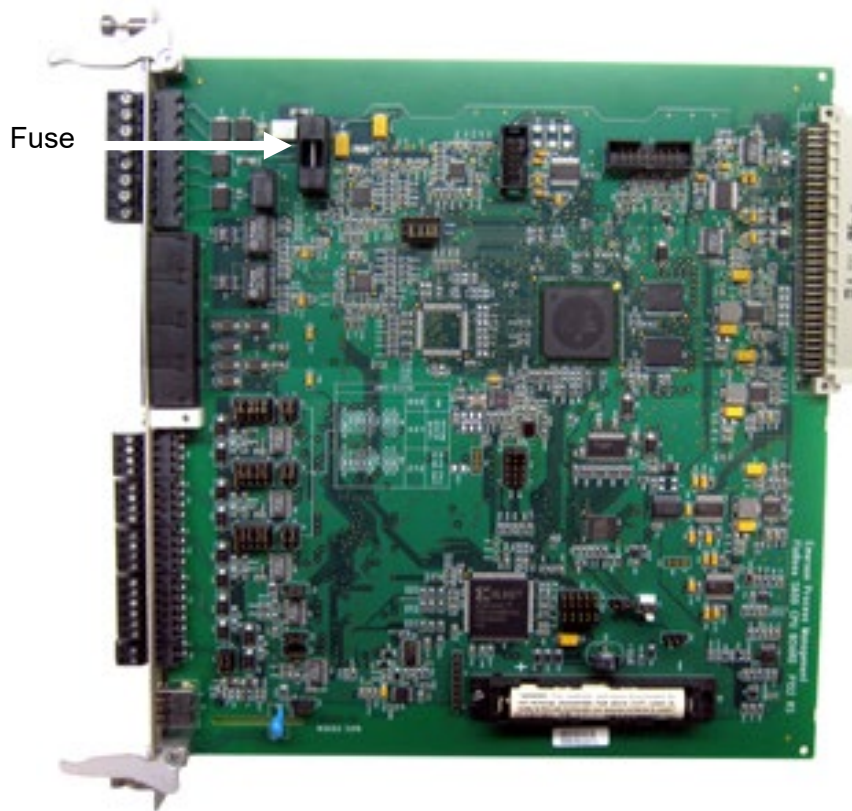

*Figure 8-1. Fuse Location*

To change a fuse:

1. Switch off the power supply. Remove any connections.
2. Unscrew and remove the CPU module from the S600+ case.
3. Remove the fuse gently from its housing, using only **light** pressure.
4. Check the integrity of the fuse. If necessary, replace it **only** with a 20 mm x 5 mm 2.5 Amp anti-surge fuse.

---

**Note:** Using a fuse with a higher current rating invalidates the S600+ warranty.

---

5. Replace the fuse, checking to be sure it is secure in its housing.
6. Replace the CPU module into the case.
7. Replace all connections.
8. Switch on the power supply.



## Appendix A – Glossary

---

**Note:** This is a **generalised** glossary of terms. Not all the terms may necessarily correspond to the particular device or software described in this manual. For that reason, the term “ROC” identifies all varieties of remote operations controllers and flow computers (including ROC800-Series, ROC800L, ROC300-Series, FloBoss™ 107, FloBoss 100-Series, FloBoss 600+, FloBoss 500-Series, FloBoss 407 units, and DL8000 Presets).

---

### A

---

<b>ADC</b>	Analog to <b>D</b> igital <b>C</b> onverter. Used to convert analog inputs (AI) to a format the flow computer can use. Also known as A/D Converter.
<b>Address</b>	A character or group of characters used to identify a particular item (such as a particular area of memory or a particular computer on a communication link with many other computers).
<b>AGA</b>	<b>A</b> merican <b>G</b> as <b>A</b> ssociation. A professional organisation that oversees the AGA3 (orifice), AGA5 (heating value), AGA7 (turbine), AGA8 (compressibility), AGA9 (Ultrasonic), and AGA11 (Coriolis) gas flow calculation standards. See <a href="http://www.aga.org">http://www.aga.org</a> .
<b>AI</b>	Analogue input, also known as ANIN.
<b>Alphanumeric</b>	Consisting of only the letters A through Z and the numbers 0 through 9.
<b>Analogue</b>	A signal with no defined steps, its value being determined by its size.
<b>Annubar</b>	A primary flow element that operates by sensing an impact pressure and a reference pressure through multiple sensing ports connected to dual averaging plenums. The resultant difference is a differential pressure signal. Sensing ports are located on both the up- and downstream sides of the flow element. The number of ports is proportional to the pipe diameter.
<b>ANIN</b>	<b>A</b> nalogue <b>i</b> nput, also known as AI.
<b>ANOUT</b>	<b>A</b> nalogue <b>o</b> utput, also known as AO.
<b>ANSI</b>	<b>A</b> merican <b>N</b> ational <b>S</b> tandards <b>I</b> nstitute. An organization responsible for approving U.S. standards in many areas, including computers and communications. Standards approved by this organisation are often called ANSI standards (for example, ANSI C is the version of the C language approved by ANSI). ANSI is a member of ISO. See <a href="http://www.ansi.org">http://www.ansi.org</a> .
<b>ASCII</b>	<b>A</b> merican <b>S</b> tandard <b>C</b> ode for <b>I</b> nformation <b>I</b> nterchange. Numeric values assigned to letters, numbers, and other characters to enable exchange of information between devices (for example, “A” = 65, “B”=66, and so on).
<b>AWG</b>	<b>A</b> merican <b>W</b> ire <b>G</b> auge, a system of sizing wiring.

### B

---

<b>Baud</b>	An indicator of the rate of serial data transfer (for example, a baud rate of 10 indicates 10 bits per second).
<b>Basetime</b>	The end of day time when any daily, weekly, or monthly reports print; also known as “contract hour.” S600 supports three basetimes.
<b>Batch control</b>	A system option used to allow a liquid station within the S600 to control a number of streams to dispatch a precise amount of product. If batch control is required, it should be enabled on all relevant streams and on the station settings during the configuration generation stage.
<b>Baud rate</b>	An indicator of the rate of serial data transfer (for example, a baud rate of 10 indicates 10 bits per second, or approximately 1 character per second).

<b>Binary</b>	Numbers in base 2 (that is, only numbers 0 and 1 are used). May be represented as a digital signal and referred to as True/False, High/Low, or On/Off.
<b>Bit</b>	A <b>binary digit</b> , either a binary 0 or 1. One byte is the amount of memory needed to store each character of information (text or numbers). Eight bits constitute one byte (or character).
<b>Bit Link</b>	A bridge (also known as a jumper) that closes an electrical circuit. Typically a bit link consists of a plastic plug that fits over a pair of protruding pins. Placing a bit link over a different set of pins allows you to change a board's parameters.
<b>Bit switch</b>	Switches that represent data bits by on or off state.
<b>Buffer</b>	A device inserted between devices to match impedance, equipment speeds, or to supply additional drive capability. Also, a storage area for data that compensates for the speed difference when transferring data from one device to another; usually refers to an area reserved for I/O operations into which data is either read or from which data is written.
<b>Bus</b>	One or more conductors used as a path over which information transmits.
<b>Byte</b>	Block of 8 bits, which can define 256 states (0 through 255).

---

**C**

---

<b>Calorific value (CV)</b>	Superior calorific value (CV) is the amount of heat which could be released by the complete combustion in air of a specified quantity of gas, in such a way that the pressure at which the reaction takes place remains constant, and all the products of combustion are returned to the same specified temperature as that of the reactants, all of these products being in the gaseous state except for water formed by combustion, which is condensed to the liquid state (source ISO6976, 1995). CV can also be calculated in accordance with AGA Report No. 5. For inferior calorific value, water remains in a gaseous state (vapour).
<b>CATS</b>	<b>Common Area Transmission System</b> . An agreed standard for measurement of gases and light hydrocarbons which are to be delivered to and redelivered for the CATS Transportation Facilities and Input Facilities (EU only).
<b>Cold Start</b>	A process of starting the FloBoss S600 that copies the configuration file from Flash memory.
<b>Config600 software</b>	PC-based software tool used to configure the S600.
<b>Constants</b>	Numbers that only infrequently change. Examples would include the conversion value between Degrees Celsius and Degrees Fahrenheit or pipe diameter.
<b>Control bus</b>	Bus connections for control signals (such as read/write).
<b>CPU</b>	<b>Central Processing Unit</b> ; in the S600, the CPU module (P152).
<b>CTL_CPL</b>	Factors for the <b>C</b> orrection for the <b>t</b> emperature of the <b>l</b> iquid and <b>c</b> orrection for the <b>p</b> ressure of the <b>l</b> iquid. In the Calculations portion of the Config600 Configuration Generator, this option is set to include the Liquid Volume Correction Table for a US configuration (tables 23, 24, 53, or 54).
<b>CTS</b>	<b>C</b> lear to <b>S</b> end. The signal asserted (logic "0", positive voltage) by the remote device to inform the flow computer that transmission may begin. RTS and CTS are commonly used as handshaking signals to moderate the flow of data into the remote device.

---

**D**

---

<b>DAC</b>	<b>D</b> igital to <b>A</b> nalog <b>c</b> onverter, also known as the D/A converter. Used to convert the digital signals used within the S600 to an analog value for use with an analog transducer or for an analog readout.
<b>Databus</b>	A group of bi-directional lines capable of transferring data to and from the CPU storage and peripheral devices.

<b>DCS</b>	<b>D</b> istributed <b>C</b> ontrol <b>S</b> ystem. A computer system which manages the process of a plant or site.
<b>DCU</b>	<b>D</b> ata <b>C</b> oncentrator <b>U</b> nit. Used to connect one device (such as a printer) to multiple S600s. Control of the shared device is determined by the hardware handshaking lines of the RS-232 port.
<b>Densitometer</b>	Transducer used to measure the density of the product at current conditions in the pipework where it is mounted.
<b>DI</b>	<b>D</b> igital input, as known as DIGIN.
<b>Digital</b>	A signal with only two states, such as on/off, input/output, or 5V/0V.
<b>DIN</b>	<b>D</b> eutsches Institut fur <b>N</b> ormung. German Standard.
<b>Discrepancy</b>	Used to check the difference between a measured variable and a preset value. For example, if Flow Discrepancy was selected during the generation phase, the S600 would check the current uncorrected volume flow rate against the proved uncorrected volume flow rate. If the discrepancy exceeded the preset limit, the S600 would raise an alarm indicating that a prove was required.  <b>Note:</b> This example is only applicable to a liquid turbine configuration.
<b>DMS</b>	<b>D</b> aniel <b>M</b> etering <b>S</b> upervisory. The DMS consists of a server performing the supervisory calculations, controls, and reporting and one or more workstations providing the human-machine interface. The workstations are connected to the server via a LAN using TCP/IP protocol and are normally designed around Windows NT or Unix and Oracle development software.
<b>DO</b>	<b>D</b> igital output, also known as DIGOUT.
<b>DP</b>	<b>D</b> ifferential <b>P</b> ressure.
<b>DPR</b>	<b>D</b> ual <b>P</b> ulse <b>R</b> eceiver or turbine input.
<b>DRAM</b>	<b>D</b> ynamic <b>R</b> andom- <b>A</b> ccess <b>M</b> emory. Volatile storage memory used in the S600. When power is removed from the S600, the contents of the DRAM memory are lost.
<b>DUI</b>	<b>D</b> aniel <b>U</b> ltrasonic <b>I</b> nterface. This Windows-based package superseded the Daniel VWI package for communicating with an ultrasonic meter. The S600 can be set to communicate with an ultrasonic meter and also pass the DUI communications through to the meter.
<b>DVM</b>	<b>D</b> igital <b>v</b> oltmeter.
<b>DVS</b>	<b>D</b> ual- <b>V</b> ariable <b>S</b> ensor. A device that provides static and differential pressure inputs to a ROC.

---

**E**

<b>E-Format</b>	Mathematical notation where the mantissa is any number greater than –10 and less than 10 and the exponent is the multiplier.
<b>EEPROM</b>	<b>E</b> lectrically <b>E</b> rasable <b>P</b> rogrammable <b>R</b> ead <b>O</b> nly <b>M</b> emory, a non-volatile memory chip which may be erased and reprogrammed electronically.
<b>Ethernet</b>	A 10- or 100-megabit-per-second (Mbps) baseband-type network that uses the contention-based CMSA/CD media access method. Invented by Robert Metcalf at Xerox's Palo Alto Research Center in the mid-1970s.
<b>Exponent</b>	Base 10 multiplier.
<b>EU</b>	<b>E</b> uropean <b>U</b> nion.

---

**F, G**

<b>Flash memory</b>	Non-volatile storage memory. Although slower to access than SRAM and DRAM, once programmed flash memory retains the data and requires no further support. In the S600, configuration files and the operating system are typically stored in flash memory. Write protect jumpers are used to prevent accidental programming of flash memory.
<b>Flow Balance</b>	Used to balance the flow through a liquid system so a required flow rate can be attained through a prover.

<b>Flow Switching</b>	This option allows the station within the S600 to control the number of streams open according to the current flow rates. If flow switching is required it should be enabled on all relevant streams and on the station settings during the generation phase.
<b>FRQ</b>	Frequency input.

---

**H**

---

<b>HART®</b>	<b>H</b> ighway <b>A</b> ddressable <b>R</b> emote <b>T</b> ransducer (or HART) is a communication protocol designed for industrial process measurement and control applications. It combines both analogue and digital communication and can communicate a single variable using a 4-20 mA analogue signal, while also communicating added information on a digital signal.
<b>Hex</b>	Hexadecimal, referring to numbers in base 16 (that is, numbers from 0 through 9 and letters from A through F).
<b>Heating Value (HV)</b>	See Calorific Value (CV).
<b>Holding Register</b>	Analog Output number value to be read.
<b>Hz</b>	Hertz.

---

**I, J, K**

---

<b>Integer</b>	Any positive or negative whole number, including zero.
<b>Intelligent I/O</b>	The Intelligent Input Output module (P144), also known as "IIO".
<b>I/O</b>	Input and Output.
<b>IP</b>	Institute of <b>P</b> etroleum or Ingress protection standard, referring to British standard 5420 or International Electro-Technical Commission standard 144.
<b>IP2</b>	In the calculations section of the generator, this option includes the Liquid Volume Correction Tables (53 or 54) for a non-US configuration.
<b>IPL600</b>	Interactive program loader; a tool used to transfer application programs from a PC to the S600.
<b>IS</b>	<b>I</b> ntrinsic <b>S</b> afe. A technique used to prevent excess electrical energy, or faults, in instrumentation from causing explosions in hazardous atmospheres. Often found in the process industry. It is the only protection method accepted for use in Zone 0 hazardous areas.
<b>ISO</b>	<b>I</b> nternational <b>O</b> rganisation for <b>S</b> tandards. A voluntary, non-treaty organization founded in 1946 which is responsible for creating international standards in many areas, including computers and communications. Its members are the national standards organizations of the 89 member countries, including ANSI for the U.S. See <a href="http://www.iso.org">http://www.iso.org</a> .
<b>ISO 5167</b>	Measurement of fluid flow by means of pressure differential devices (such as orifice plates, nozzles, or Venturi tubes) inserted in circular cross-section conduits.
<b>ISO 6976</b>	Natural gas calculation of calorific values, density, relative density and Wobbe index from composition.

---

**L**

---

<b>LED</b>	<b>L</b> ight- <b>E</b> mitting <b>D</b> iode (an indicator). On the S600, a light to show the status of the S600 in a visual form. As examples, the Alarm LED shows the status of the machine by the color of the LED and communications between the main processor board and the IO boards is shown on the rear of the flow computer by use of the transmit and receive LEDs.
------------	---

---

**M**

---

<b>Mantissa</b>	Numerically significant part of a floating-point number.
<b>Meter Correction</b>	An option applicable only to liquid turbine applications and used to correct the flow rate due to temperature and pressure effects on the body of the meter.

<b>Meter Linearisation</b>	An option used to correct the K Factor or Meter Factor of a pulse input according to the input frequency. This is used to correct discrepancies caused by the non-linearity of the transducer connected to the pulse input.
<b>Modbus</b>	A device communications protocol developed by Gould-Modicon and used on the station supervisory computer data link.
<b>Modem</b>	<b>Modulator Demodulator</b> ; a device used to communicate with other equipment using a telephone network.
<b>Modulate</b>	Superimposing one signal upon another.
<b>MOV</b>	<b>Motor Operated Valve</b> ; a valve that is motorized and requires a signal to drive the valve open, a signal to drive the valve closed, and has a two signals returning to the S600 to describe the valve as being open, closed, moving, or illegal.
<b>Multiplexor</b>	Multiple Input Selector.

---

## N

<b>Noise</b>	Random electrical interference.
<b>Non-volatile Memory</b>	Memory type that retains data when the power supply is disconnected.
<b>NX-19</b>	An AGA report developed for the calculation of supercompressibility factors.

---

## O

<b>Object</b>	Generally, any item that can be individually selected and manipulated. This can include shapes and pictures that appear on a display screen as well as less-tangible software entities. In object-oriented programming, for example, an object is a self-contained entity that consists of both data and procedures to manipulate the data.
<b>Octal</b>	Numbers in base 8 (that is, numbers 0 through 8).
<b>Off-line</b>	Accomplished while the target device is not connected (by a communications link). For example, "off-line configuration" refers to configuring an electronic file that is later loaded onto the S600.
<b>On-line</b>	Accomplished while connected (by a communications link) to the target device. For example, "on-line configuration" refers to configuring an S600 while connected to it, so you can view the current parameter values and immediately load new values.
<b>Open Collector</b>	Digital output that is driven by a transistor and requires external power.
<b>Opto-Isolator</b>	Optical device for connecting signals while maintaining electrical isolation.
<b>Overrange</b>	Over the preset current limit for the A/D Converter.

---

## P, Q

<b>PCB</b>	<b>Printed circuit board</b> .
<b>PID</b>	Three-term control action that uses <b>P</b> roportional, <b>I</b> ntegral, and <b>D</b> erivative components to modify a control output, with the goal of achieving a measured process variable at a set point.
<b>Peer to Peer Link</b>	Communications mode implemented by giving each communication node both server and client capabilities.
<b>Port</b>	Group of inputs or outputs to the computer.
<b>Program</b>	Series of instructions.
<b>Protocol</b>	Precise description of data interchange over a telemetry link.
<b>Prove Sequence</b>	An order of events set into the S600 to perform a calibration (or "prove") of flow balancing, stability checking, or valve-routing.
<b>PRT</b>	<b>Platinum resistance thermometer</b> . See also RTD.
<b>PSU</b>	<b>Power supply unit</b> .
<b>PTZ</b>	Calculation of Compressibility, Relative Density and Line Density using the Solartron 7915 PTZ method.

---

**R**

---

<b>RAM</b>	<b>Random-access memory.</b> Volatile memory that becomes unreliable when power is removed from the computer.
<b>Relative Density (RD)</b>	<p>Liquid relative density: the ratio of the mass of a given volume of liquid at 15°C (or other standard temperature, such as 60°F) to mass of an equal volume of pure water at the same temperature. When reporting results, explicitly state the standard reference temperature (for example, relative density 15/15°C). [Source API Vocabulary 1994].</p> <p>Gas relative density: As above except that air is used as the reference instead of water.</p> <p>Ideal and Real gas relative density. See Specific Gravity.</p> <p>Note: Water at 15°C is 999.058 kg/m<sup>3</sup>.  Water at 60°F is 999.012 kg/m<sup>3</sup>. [Source API 2540 volume X]  Air at 15°C is 1.2255 kg/m<sup>3</sup>.</p>
<b>ROM</b>	<b>Read-only memory (fixed storage).</b> Typically used to store firmware. Flash memory. This type of memory cannot be written to by default; however, some modern memory allows writing to occur under certain conditions.
<b>RS-232</b>	Voltage standard for serial data transmission.
<b>RTD</b>	<b>Resistance thermometer device.</b>
<b>RTS</b>	<b>Request to Send.</b> This signal is asserted (logic '0', positive voltage) to prepare the other device for accepting transmitted data from the flow computer. Such preparation might include enabling the receive circuits, or setting up the channel direction in half-duplex applications. When the other device is ready, it acknowledges by asserting Clear to Send.
<b>RTU</b>	<b>Remote terminal unit.</b>
<b>RTV</b>	<b>Room temperature vulcanizing,</b> typically a sealant or caulk such as silicon rubber.
<b>RX or RXD</b>	Received information.

---

**S**

---

<b>Sampler</b>	Device used to take samples of the product in the pipework where it is mounted. This can either be timed according to throughput or number of samples required in a certain timeframe.
<b>Security Code</b>	Codes that limit operator access to software parameters; typically stored in micro memory.
<b>Specific Gravity (SG)</b>	<p>Ideal gas relative density (specific gravity), <math>G_i</math> is defined as the ratio of the ideal density of the gas to the ideal density of dry air at the same reference conditions of pressure and temperature. Since the ideal densities are defined at the same reference conditions of pressure and temperature, the ratio reduces to a ratio of molar masses (molecular weights). [Source AGA3 1992]</p> <p>Real gas relative density (specific gravity), <math>G_r</math>, is defined as the ratio of the real density of the gas to the real density of dry air at the same reference conditions of pressure and temperature. To correctly apply the real gas relative density (specific gravity) to the flow calculation, the reference conditions for the determination of the real gas relative density (specific gravity) must be the same as the base conditions for the flow calculation. [Source AGA3 1992]</p> <p>See also Relative Density (RD).</p> <p><b>Note:</b> Real relative density differs from ideal relative density in that the ratio of the gas compressibilities is also taken into account.</p>
<b>SRAM</b>	<b>Static random-access memory.</b> Stores data as long as power is applied; typically backed up by a lithium battery or supercapacitor.
<b>S600+</b>	FloBoss™ S600 Flow Computer fitted with the new CPU module with the ColdFire MPC8313C 333 MHz with integral floating point processor.

---

**T**

---

<b>Task</b>	An operating system concept that refers to the combination of a program's execution and the operating system's bookkeeping information. Whenever a program executes, the operating system creates a new task for it.
<b>TCP/IP</b>	Transmission Control Protocol/Internet Protocol.
<b>Time and Flow Averaging</b>	An option that allows the S600 to average process variables based on time, flow or time and flow.
<b>Totaliser</b>	Area of RAM for integrating totals.
<b>Transducer</b>	Device that converts energy from one state to another.
<b>TRI-REG</b>	Triple register; an area of RAM where data is stored in triplicate, normally used to store totals.
<b>TX</b>	Transmitted information.

---

**U**

---

<b>Underrange</b>	Under the preset current limit for the A/C Converter.
-------------------	---

---

**V**

---

<b>Variables</b>	Changeable values.
<b>V-Cone®</b>	A differential pressure device produced by McCrometer.
<b>Volatile</b>	Memory that is unstable in the absence of power.
<b>VWI</b>	View Interface; now superseded by the Daniel Ultrasonic Interface.

---

**W**

---

<b>Warm Start</b>	An S600 startup process in which the configuration remains untouched.
<b>Watchdog</b>	A hardware circuit that monitors correct program operation and restarts the program in the event of malfunction.

*[This page is intentionally left blank.]*



## Appendix B – Front Panel Navigation

### In This Chapter

---

B.1	Man Menu .....	B-2
B.2	Rates Menu .....	B-2
B.3	Totals Menu .....	B-3
B.4	Operator Menu.....	B-4
B.5	Plant I/O Menu.....	B-5
B.6	System Settings Menu.....	B-5
B.7	Tech/Engineer Menu .....	B-6
B.8	Calculations Menu .....	B-7

---

This appendix describes the default menu options of the S600+ front panel display. Refer to *Chapter 5, Front Panel*, for a discussion of the layout and navigation basics of the front panel.

The S600+ firmware organizes data in a structured database of parameters, such as Totals, I/O, and Calculations. The database groups the parameters logically by data points in a matrix of display screens. For example, the parameters used for averaging totals are grouped together.

---

**Note:** The content of the display screens is specific to your application. The menus in this appendix are provided **only** as an example. Although details may vary between different applications, the basic principles described in this appendix remain the same.

---

For this appendix, the defaults for the screens assumed a configuration with two stations (Gas and Liquid) and four streams. The Gas DP stream is assigned to station 1, and the Liquid Coriolis is assigned to station 2.

Remember, your specific application may vary from these illustrations. For example, if your application has fewer stations and more streams, you will see more stream choices and fewer station choices than shown in this example. If you have different types of streams, you will see parameters and submenu choices not listed here. This appendix is provided as an illustration of how to generally navigate through the S600+ front panel displays.

## B.1 Main Menu

Once startup completes, the Main menu displays:

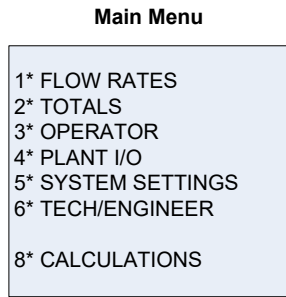

## B.2 Flow Rates Menu

The system uses all the parameters in this group to calculate the various flow rates.

**Note:** In this menu structure, **FR** refers to Flow Rate.

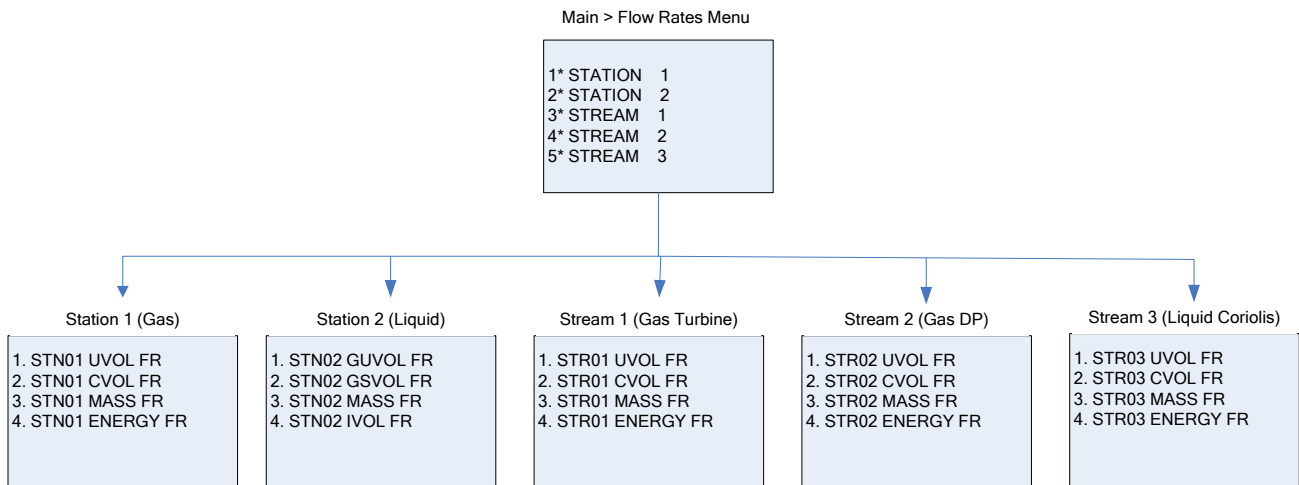

## B.3 Totals Menu

The system uses all parameters in this group in calculating the various totals. If one of the streams is a prover, the stream does not appear on this menu.

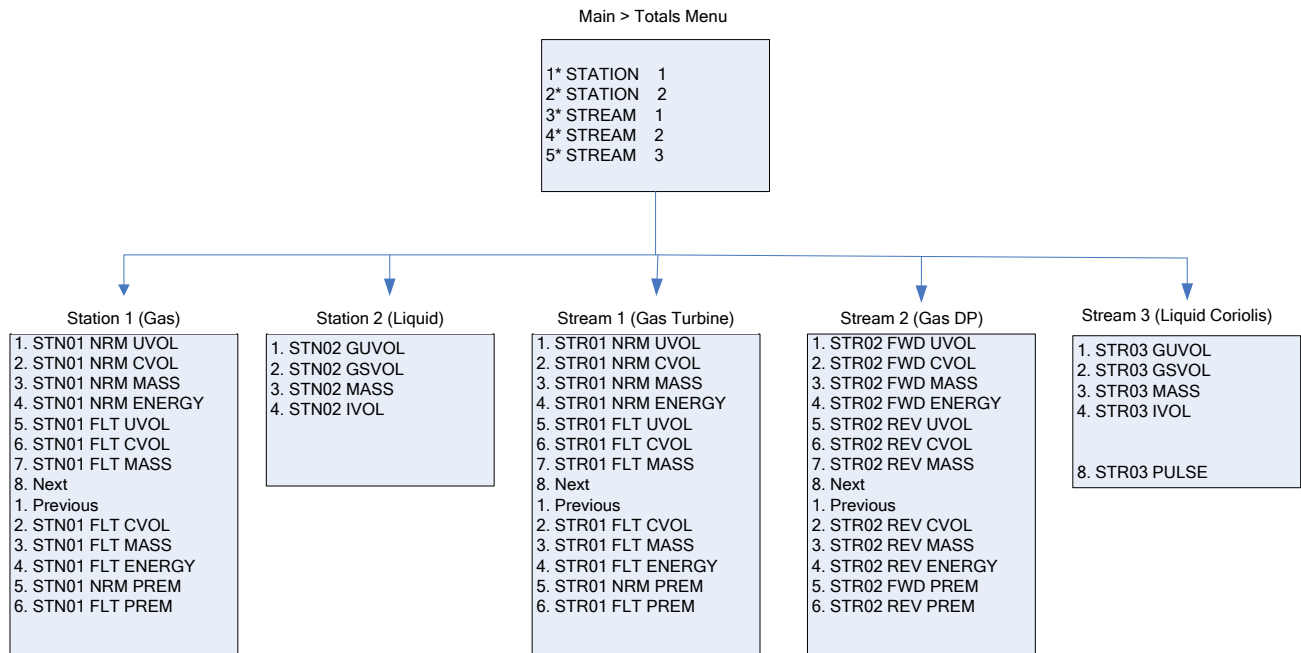

## B.4 Operator Menu

The parameters in this group are values and statuses you typically want to view when monitoring the operation of the S600+.

**Note:** **AVE T&P** refers to the average temperature and pressure parameters. **STAT&CTRL** refers to status and control parameters.

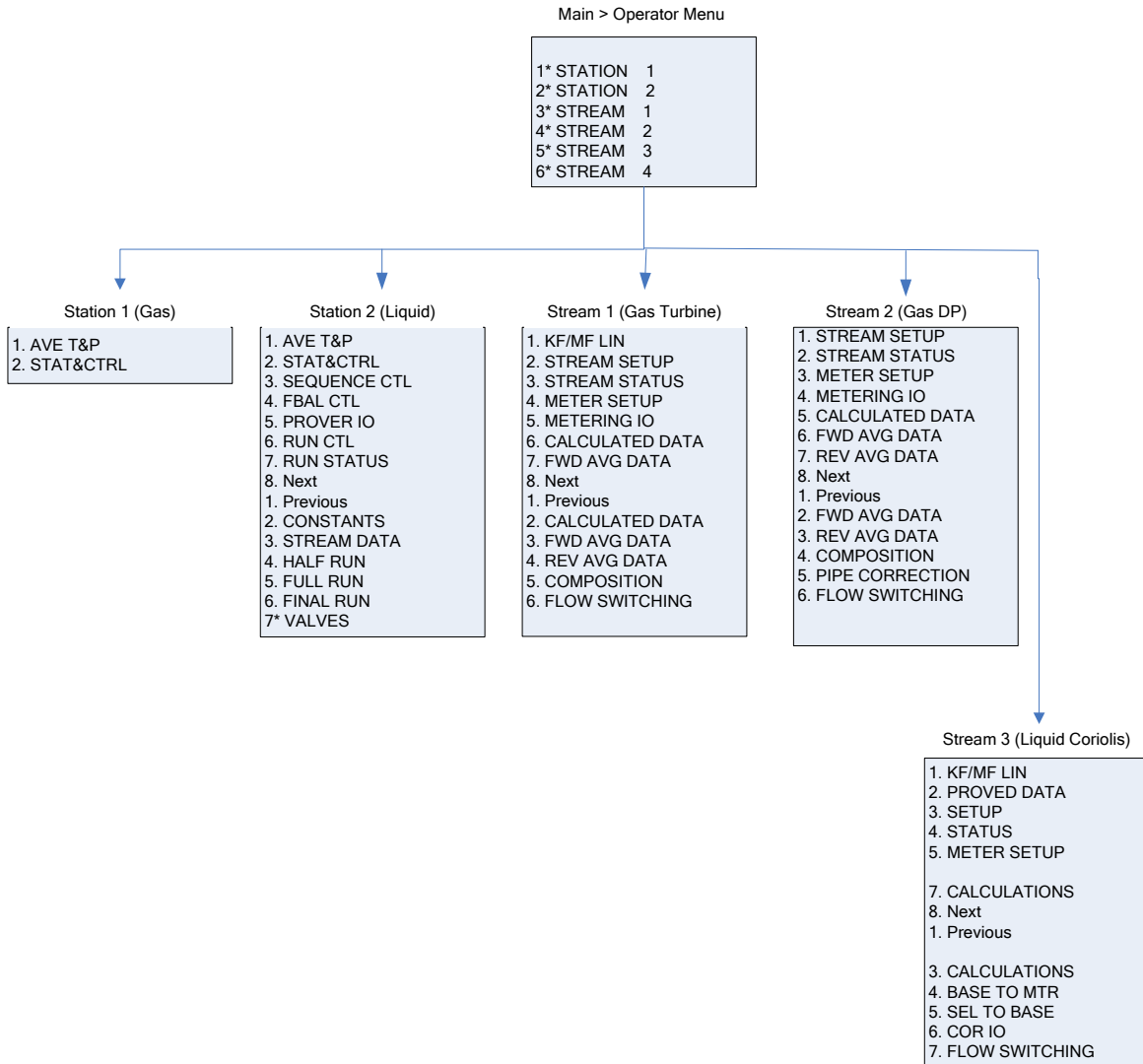

## B.5 Plant I/O Menu

The parameters in this group are the values, limits, and status of the field I/O.

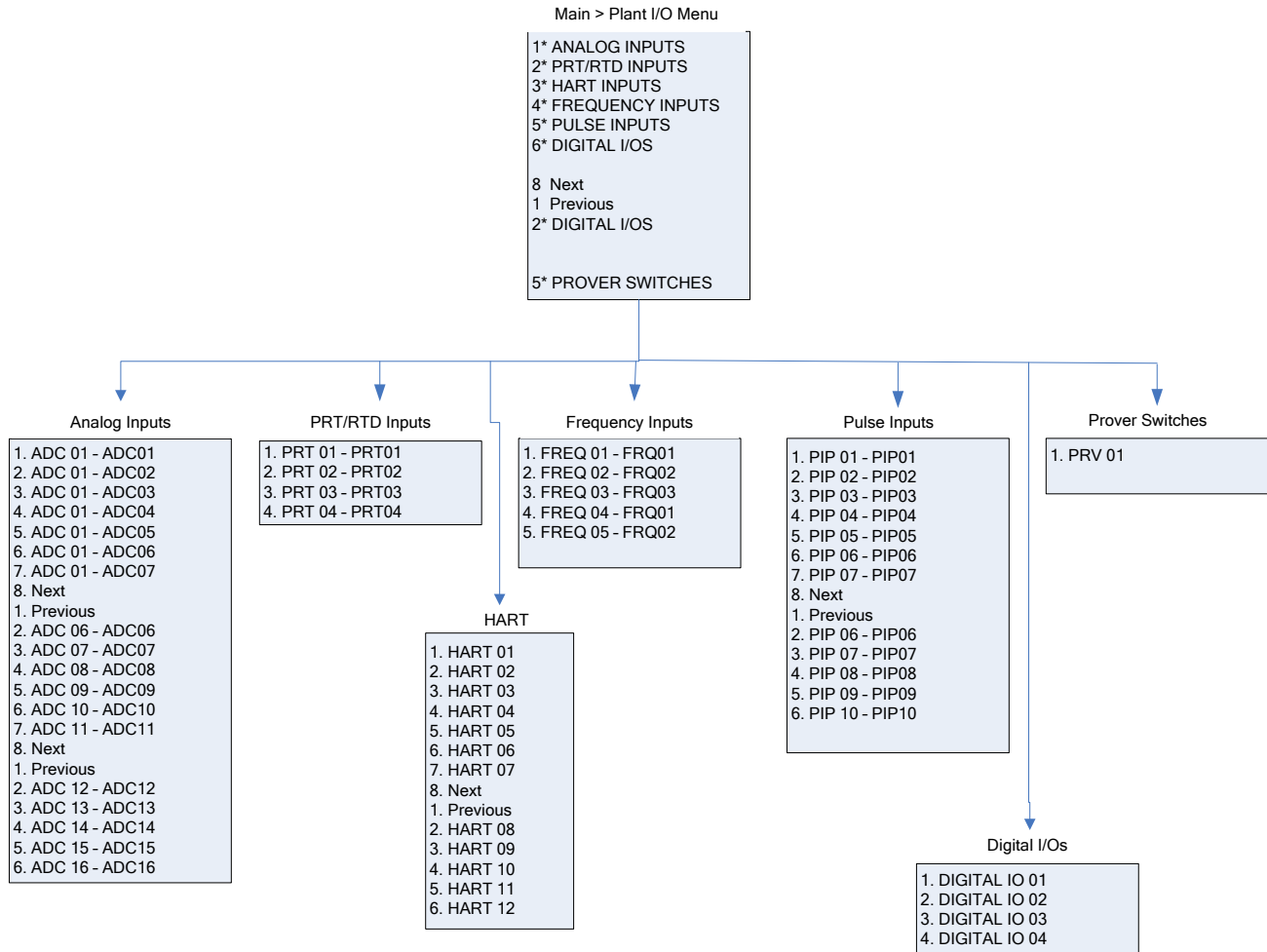

## B.6 System Settings Menu

The system uses the parameters in this group in report gathering or for maintaining the S600+. The Unit Setup submenu contains the parameters regarding the Units of Measure.

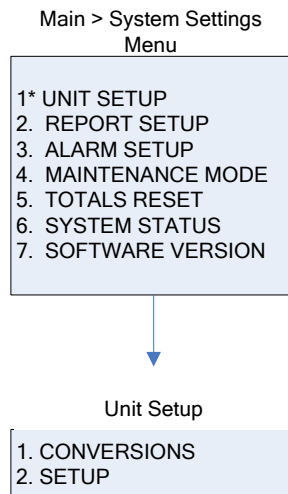

## B.7 Tech/Engineer Menu

The parameters in this group are for advanced users or factory personnel. The Date & Time menu option sets the format for reporting the date and time. The Security menu option sets the security parameters.

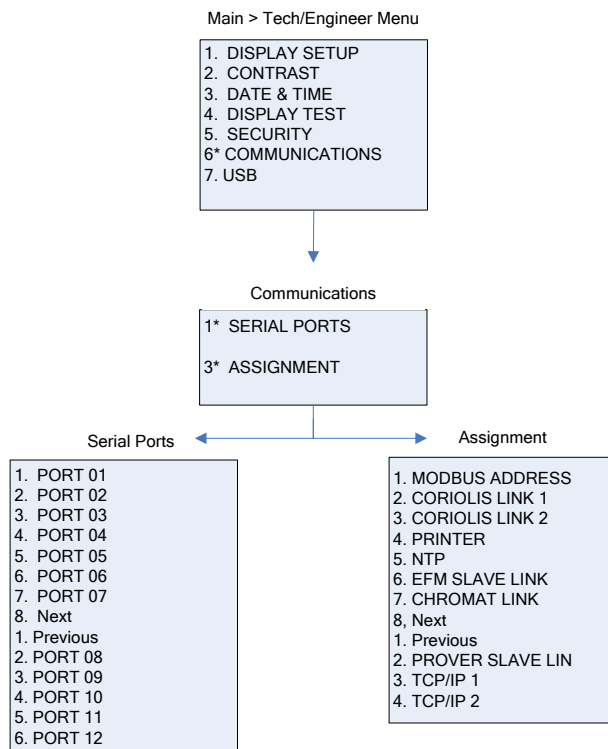

## B.8 Calculations Menu

The parameters in this group are all used in and result from system calculations and are further subgrouped as parameters relating to the values going into the calculations (as input) and results of the calculations (as output).

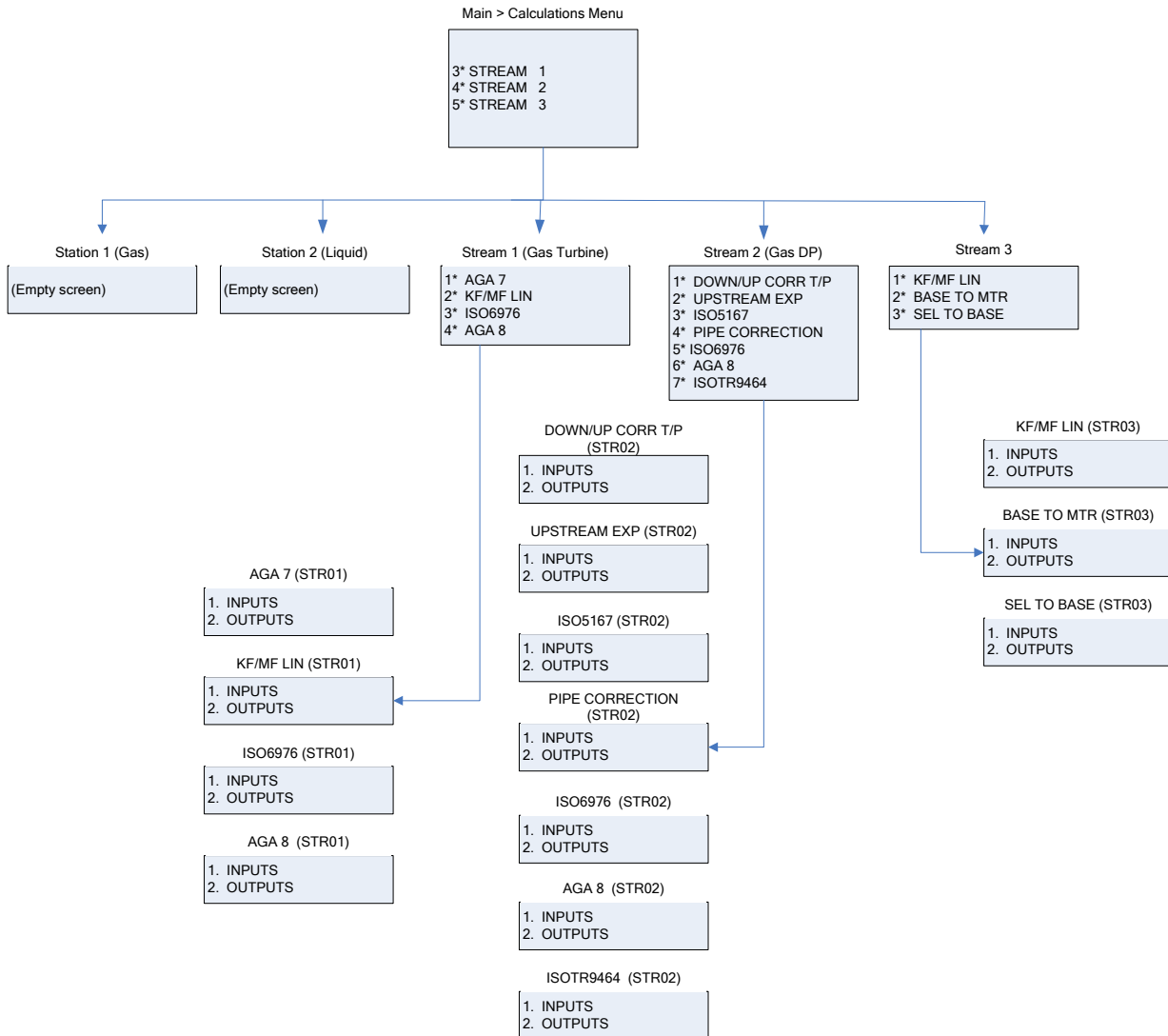

*[This page is intentionally left blank.]*



# Index

## 1

100BASE-T ..... 3-7

## A

Accept ..... 5-4  
 ADC ..... A-1  
 Address ..... A-1  
 AGA ..... A-1  
 AI ..... A-1  
 Alarm ..... 5-4  
 Alarm LED ..... 5-4  
 Alarm Log ..... 5-13  
 All Alarms ..... 5-13  
 American ..... 4-13  
 Analog Outputs (DAC) ..... 4-5  
 Analogue ..... A-1  
 Analogue Inputs (ANIN) ..... 4-3  
 ANIN ..... A-1  
 Annubar ..... A-1  
 ANOUT ..... A-1  
 ANSI ..... A-1  
 Archived Reports ..... 5-13  
 Arrow key ..... 5-3  
 ASCII ..... A-1  
 AWG ..... A-1

## B

Backup  
   Battery ..... 3-4  
 Basetime ..... A-1  
 Batch control ..... A-1  
 Battery Backup ..... 3-4  
 Baud rate ..... A-1  
 Baug ..... A-1  
 Binary ..... A-2  
 Bit ..... A-2  
 Bit link (jumper) ..... A-2  
 Bit Links ..... 3-9  
   I/O Module ..... 4-14  
   Prover Module ..... 4-24  
 Bit switch ..... A-2  
 Buffer ..... A-2  
 Bus ..... A-2  
 Bytes ..... A-2

## C

Calendar Van Dusen ..... 4-13  
 CATS ..... A-2  
 Change ..... 5-3  
 Changing configurations ..... 5-16  
 Changing display options ..... 5-9  
 Changing display values ..... 5-10  
 Changing the Fuse ..... 8-6

Choosing configurations ..... 5-16  
 Clear ..... 5-3  
 Clear SRAM ..... 8-5  
 Cold start ..... A-2  
 Cold Start ..... 7-2  
 COM2 ..... 3-8  
 Communications ..... 3-5  
 Config Report ..... 5-13  
 Config Transfer ..... 1-6  
 Config600 (Pro/Lite/Lite+)  
   Technical Information ..... 1-8  
 Config600t ..... A-2  
 Configurations  
   selecting ..... 5-16  
 Constants ..... A-2  
 Constants Log ..... 5-13  
 Control bus ..... A-2  
 CPU ..... A-2  
 CPU module ..... 3-1  
 CTL\_CPL ..... A-2  
 CTS ..... A-2  
 Current Alarms ..... 5-13  
 Current Report ..... 5-13  
 CV ..... A-2

## D

DAC ..... A-2  
 Data display ..... 5-5  
 Data display page ..... 5-7  
 Databus ..... A-2  
 DCS ..... A-2  
 DCU ..... A-3  
 Default display ..... 5-12  
 Densitometer ..... A-3  
 DI ..... A-3  
 Digital Inputs (DIGIN) ..... 4-6, 4-19  
 Digital Outputs  
   DIGOUT ..... 4-8, 4-20  
 DIN ..... 4-13, A-3  
 Discrepancy ..... A-3  
 DISP key ..... 5-8  
 Display ..... 5-3  
   LCD ..... 5-4  
 Display Dump ..... 5-13  
 Display Shortcut ..... 5-12  
 DMS ..... A-3  
 DP ..... A-3  
 DPR ..... A-3  
 DRAM ..... A-3  
 DUI ..... A-3  
 DVC ..... A-3  
 DVS ..... A-3

## E

E Format ..... A-3  
 Editing values ..... 5-5

EEPROM .....	A-3	4-12. Digital Output Schematic (24V Switched Indicator) .....	4-8
Enabling USB .....	5-14	4-13. Pulse Input Schematic (with -12V P148 Mezzanine Module) .....	4-10
Enter .....	5-3	4-14. Pulse Input Schematic (with 24 V P148 Mezzanine Module) .....	4-10
Environmental Considerations.....	2-2	4-15. Pulse Output Schematic.....	4-10
Ethernet .....	A-3	4-16. Raw Pulse Output Schematic .....	4-11
Ethernet LAN Port.....	3-7	4-17. Frequency Input Schematic (with IS Barrier and AC-Coupled).....	4-12
Ethernet ports .....	1-3	4-18. Frequency Input Schematic (without IS Barrier and DC-Coupled).....	4-12
EU .....	A-3	4-19. Frequency Input Schematic (with MTL Isolator in Two-wire Mode).....	4-13
Event Log.....	5-13	4-20. PRT/PRD Input Schematic.....	4-14
Exponent.....	5-3, A-3	4-21. Prover Module (P154).....	4-17
Exponential Format.....	5-12	4-22. Prover Module .....	4-17
Exporting reports (USB) .....	5-14	4-23. Prover Module Terminations .....	4-19
<b>F</b>			
F Keys.....	5-2	4-24. Digital Input Schematic (Open Collector Device) .....	4-19
Figures		4-25. Digital Input Schematic (Relay).....	4-19
1-1. FloBoss S600+ Flow Computer .....	1-2	4-26. Digital Output Schematic (Relay).....	4-21
1-2. CPU Module.....	1-4	4-27. Digital Output Schematic (24V Switched Indicator) .....	4-21
1-3. Intelligent I/O Module .....	1-5	4-28. Pulse Input Schematic (with 24 V P148 Mezzanine Module).....	4-22
1-4. Front Display Panel.....	1-5	4-29. Pulse Output Schematic.....	4-22
2-1. FloBoss S600+ System Components ....	2-2	4-30. Frequency Input Schematic (with IS Barrier and AC-Coupled).....	4-23
2-2. Removing the Front Panel .....	2-3	4-31. Frequency Input Schematic (without IS Barrier and DC-Coupled).....	4-23
2-3. Lifted Front Panel.....	2-4	4-32. HART Module (P188).....	4-26
2-4. Remove Connector .....	2-5	4-33. HART Device.....	4-27
2-5. Panel Mount Dimensions .....	2-6	4-34. HART Device and Handheld Communicator .....	4-27
2-6. Panel Cutout Dimensions .....	2-7	4-35. HART Device without Handheld Communicator .....	4-28
2-7. Panel Mount Support .....	2-7	5-1. Front Panel.....	5-1
2-8. Unscrewing the Retention Screws .....	2-9	5-2. Front Panel Port Connector .....	5-2
2-9. Using the Ejectors .....	2-9	5-3. S600+ Main Menu .....	5-5
2-10. Module Ready for Removal or Insertion .....	2-10	5-4. Editable Value .....	5-5
2-11. Screws on I/O Module.....	2-11	5-5. Progression of S600+ Menus and Data Page .....	5-6
2-12. Security Backplate in Place .....	2-12	5-6. S600+ Main Menu .....	5-7
2-13. EMISTOP Connector .....	2-12	5-7. Submenu .....	5-7
2-14. Filters on I/O Module Wiring .....	2-13	5-8. Data Display .....	5-7
2-15. Clamps on CPU Module Power & COM Connections .....	2-13	5-9. Moving between Data Pages .....	5-8
2-16. Clamps on CPU Module COM and Ethernet Connections.....	2-14	5-10. Changing a Display Option .....	5-9
3-1. CPU Module Backplate.....	3-2	5-11. Changing a Display Option .....	5-10
3-2. CPU Module.....	3-2	5-12. Changing a Display Value .....	5-10
3-3. CPU Module Terminations .....	3-3	5-13. Changing a Display Value .....	5-11
3-4. Front Panel Terminations.....	3-3	5-14. Print Options Menu .....	5-13
3-5. Pin Connections .....	3-6	5-15. USB Report Control Menu .....	5-15
3-6. Link Cable .....	3-9	5-16. USB Report Options.....	5-15
4-1. I/O Module (P144).....	4-2	5-17. Changing a Display Value.....	5-15
4-2. I/O Module.....	4-2	5-18. Changing a Display Value.....	5-16
4-3. I/O Module Terminations.....	4-3	5-19. Configuration Menu.....	5-16
4-4. Analogue Input Schematic (with IS barrier and Internal Resistor .....	4-4	6-1. Webserver Access (PCSetup) .....	6-1
4-5. Analogue Input Schematic (without IS Barrier and External Resistor).....	4-4	6-2. Webserver Access .....	6-3
4-6. Analogue Output Schematic (S600+-Powered).....	4-5	6-3. Webserver Access (Report Format).....	6-5
4-7. Analogue Output Schematic (Externally Powered Device).....	4-6	6-4. Webserver Access (Page Format).....	6-5
4-8. Analogue Output Schematic (Externally Powered through S600+) .....	4-6	6-5. Alarm Archive .....	6-6
4-9. Digital Input Schematic (Open Collector Device) .....	4-7	6-6. Alarms Screen.....	6-6
4-10. Digital Input Schematic (Relay).....	4-7		
4-11. Digital Output Schematic (Relay).....	4-8		

7-1. Main Menu and Startup Menu.....	7-1
7-2. Startup Menu.....	7-3
7-3. Network Startup Menu .....	7-4
7-4. Network Definition Menu.....	7-5
7-5. Modbus Screen.....	7-6
7-6. Modbus Screen.....	7-6
8-1. Fuse Location.....	8-6
Flash Failed.....	8-4
Flash memory.....	A-3
Flow balance.....	A-3
Flow switching.....	A-3
Four-Direction Key.....	5-3
Frequency Inputs.....	4-12, 4-23
Front Panel	
Navigation.....	B-1
Front Panel Port.....	5-2
FRQ.....	A-3
Function key.....	5-2
Fuse	
Changing.....	8-6

**H**

HART.....	4-25, A-4
HART Communications.....	1-3
HART Module.....	4-25
Hex.....	A-4
Hierarchy, menu.....	5-9
Holding register.....	A-4
HV.....	A-4
Hz.....	A-4

**I**

I/O.....	A-4
I/O Jumper Settings.....	4-14
I/O Module.....	4-1
ANIN.....	4-3
DAC.....	4-5
DIGIN.....	4-6
DIGOUT.....	4-8
Frequency Inputs.....	4-12
Jumpers.....	4-14
PRT/RTD.....	4-13
PULSEIN.....	4-9
PULSEOUT.....	4-10
RAWOUT.....	4-11
I/O modules	
Specifications.....	3-10
IIO.....	A-4
Initialization.....	7-1
Installation	
Preparing.....	2-1
Integer.....	A-4
IP.....	A-4
IP2.....	A-4
IPL600.....	1-6, A-4
IS.....	A-4
ISO.....	A-4
ISO 5167.....	A-4
ISO 6976.....	A-4

**J**

Jumpers.....	3-9
I/O Module.....	4-14
Prover Module.....	4-24

**K**

Key	
CHNG.....	5-3
DISP.....	5-3, 5-8
Enter.....	5-3
EXPT.....	5-3, 5-12
Function.....	5-12
Minus.....	5-12
Operations.....	5-3
Print.....	5-13
Keypad.....	5-2

**L**

LAN Port	
Ethernet.....	3-7
LCD Display.....	5-4
LED.....	A-4
LED, Alarm.....	5-4
LogiCalc.....	1-4

**M**

Main menu.....	5-6
Maintenance.....	8-1
Mantissa.....	A-4
Maximum cable.....	3-7
Menu	
Startup.....	7-3, 8-2
Menu hierarchy.....	5-9
Menu Keys.....	5-3
Menus.....	5-7, B-1
Messages	
Configuring.....	7-2, 7-3
Resetting.....	7-1
Restarting.....	7-1
Meter factor.....	A-4
Meter linearisation.....	A-4
Mezzanine (P148) Module.....	4-28
Modbus.....	A-4
Modbus Maps.....	5-13
Modem.....	A-5
Modulate.....	A-5
Modules	
CPU (P152).....	3-1
HART (P188).....	4-25
I/O (P144).....	4-1
Mezzanine (P148).....	4-28
Prover (P154).....	4-16
MOV.....	A-5
Multiplexer.....	A-5

**N**

Navigation	
Front Panel.....	B-1
Webserver Interface.....	6-4

Network Setup ..... 7-4  
 Noise..... A-5  
 Non-volatile memory..... A-5  
 Numeric Keys ..... 5-3  
 NX-19..... A-5

**O**

Object ..... A-5  
 Octal ..... A-5  
 Off-line ..... A-5  
 On-line ..... A-5  
 Open collector..... A-5  
 Open Source..... 1-8  
 Options  
     Changing ..... 5-9  
 Opto-isolator ..... A-5  
 Overrange..... A-5

**P**

P148 Mezzanine module ..... 4-28  
 P152 CPU module ..... 3-1  
 P154 Prover module ..... 4-16  
 P188 HART module..... 4-25  
 P190 Module..... 1-3  
 Page reference number ..... 5-5  
 Pages, data..... 5-5  
 PCB ..... A-5  
 Peer-to-peer link ..... A-5  
 PID..... A-5  
 Port ..... A-5  
 Power Supply..... 3-4  
 Print ..... 5-3, 5-13  
 Procedures  
     Changing the Fuse ..... 8-6  
     Clear SRAM ..... 8-5  
     Reflash Firmware ..... 8-4  
     Send and Reflash Config ..... 8-4  
 Program ..... A-5  
 Protocol..... A-5  
 Prove sequence..... A-5  
 Prover Board  
     PULSEIN ..... 4-22  
     PULSEOUT ..... 4-22  
 Prover Jumper Settings ..... 4-24  
 Prover module ..... 4-16  
     DIGIN..... 4-19  
 Prover Module  
     DIGOUT..... 4-20  
     Frequency Inputs..... 4-23  
     Jumpers..... 4-24  
 PRT..... A-5  
 PRT/RTD Inputs ..... 4-13  
 PSU ..... A-5  
 PTZ ..... A-5  
 Pulse Inputs  
     Turbine ..... 4-9, 4-22  
 Pulse Outputs  
     PULSEOUT ..... 4-10, 4-22

**R**

RAM ..... A-5  
 Raw Pulse Output (RAWOUT) ..... 4-11  
 RD ..... A-6  
 Reflash Config File..... 8-4  
 Reflash Firmware..... 8-4  
 ROM..... A-6  
 RS-232 ..... 3-6, A-6  
 RS-422 Port ..... 3-7  
 RS-485 Port ..... 3-7  
 RTD..... A-6  
 RTD Inputs..... 4-13  
 RTS..... A-6  
 RTU..... A-6  
 RTV..... A-6  
 RX/RXD ..... A-6

**S**

S600+ ..... 1-2, A-6  
 Sample ..... A-6  
 Security code ..... A-6  
 Security Dump ..... 5-13  
 Selecting configurations ..... 5-16  
 Send Config File ..... 8-4  
 Serial Port ..... 3-6  
 SG ..... A-6  
 Specifications  
     I/O modules ..... 3-10  
 SRAM..... 7-1, A-6  
     Clear ..... 8-5  
 Start ..... 7-1  
 Startup menu ..... 7-3, 8-2  
 Status/ID line..... 5-5  
 Submenu..... 5-7

**T**

Tables  
     1-1. Related Technical Information ..... 1-8  
     2-1. Mounting Dimensions..... 2-5  
     3-1. TB-1 Pin Connections ..... 3-4  
     3-2. TB-1 Pin Connections ..... 3-4  
     3-3. Communication Ports..... 3-6  
     3-4. COM3 and COM4 Pin Connections ..... 3-6  
     3-5. COM5, COM6, and COM7 Pin Connections ..... 3-7  
     3-6. CPU Jumpers ..... 3-9  
     3-7. I/O Module Technical Specification..... 3-10  
     4-1. ANIN Pin Connections (SKT-A) ..... 4-5  
     4-2. ANIN Pin Connections (SKT-B) ..... 4-5  
     4-3. D/A Converter Output Pin Connections (SKT-A)..... 4-6  
     4-4. DIGIN Pin Connections (SKT-B) ..... 4-7  
     4-5. DIGIN Pin Connections (SKT-C)..... 4-8  
     4-6. DIGOUT Pin Connections (SKT-B) ..... 4-9  
     4-7. DIGOUT Pin Connections (SKT-C)..... 4-9  
     4-8. Dual Pulse Input Pin Connection (SKT-C) .. 4-10  
     4-9. PULSEOUT Pin Connections (SKT-B). 4-11  
     4-10. Raw Pulse Output Pin Connections (SKT-C)..... 4-12

4-11. Frequency Input Pin Connectors (SKT-B)	4-13	LEDs .....	8-2
4-12. PRT/PRD Input Pin Connections (SKT-B)	4-14	Power Issues .....	8-2
4-13. I/O Module Jumper Settings .....	4-15	Serial Communications.....	8-3
4-14. Multiplex Mode Addressing.....	4-16	Startup Menus .....	8-2
4-15. DIGIN Pin Connectors (SKT-E) .....	4-19	Turbine Pulse Inputs .....	4-9, 4-22
4-16. DIGIN Pin Connections (SKT-F).....	4-20	TX .....	A-7
4-17. DIGOUT Pin Connections (SKT-E)....	4-21	<b>U</b>	
4-18. DIGOUT Pin Connections (SKT-F)....	4-21	Underrange .....	A-7
4-19. Dual Pulse Input Pin Connections (SKT-F)	4-22	Unlocking USB port .....	5-14
4-20. PULSEOUT Pin Connections (SKT-E) .....	4-23	USB	
4-21. Frequency Input Pin Connections (SKT-D)	4-24	Enabling/disabling .....	5-14
4-22. Prover Module Jumper Settings.....	4-24	Exporting reports .....	5-14
4-23. Node Addressing - Communications Mode	4-24	USB Port .....	3-10
Selection.....	4-24	<b>V</b>	
4-24. HART Pin Connections (Socket A) ....	4-26	Values	
4-25. HART Pin Connections (Socket B) ....	4-26	Changing .....	5-10
5-1. Front Panel Port Connections.....	5-2	Values, editing .....	5-5
Task.....	A-6	Variables .....	A-7
TCP/IP .....	A-6	V-Cone .....	A-7
Technical information		View .....	5-4
Config600 Lite .....	1-8	Volatile .....	A-7
Config600 Lite+ .....	1-8	VWI .....	A-7
Config600 Pro .....	1-8	<b>W</b>	
S600+ .....	1-8	Warm start .....	A-7
Time and flow averaging .....	A-7	Warm Start.....	7-1
Totalise .....	A-7	Watchdog.....	A-7
Transducer.....	A-7	Watchdog Relay.....	3-4
TRI-REG .....	A-7	Webserver Access .....	6-1
Troubleshooting .....	8-1	Webserver Interface .....	6-4
Flash Failed .....	8-4	Webserver mode.....	5-6
Front Panel Lighting .....	8-2	Wiring.....	3-1
I/O Fail Message .....	8-3		
I/O LEDs.....	8-3		

For customer service and technical support, visit [Emerson.com/Guardian](https://www.emerson.com/Guardian).

**North America and Latin America:**

Emerson Energy and Transportation  
Solutions  
6005 Rogerdale Road  
Houston, TX 77072 U.S.A.  
T +1 281 879 2699 | F +1 281 988 4445  
[Emerson.com/SCADAforEnergy](https://www.emerson.com/SCADAforEnergy)

**United Kingdom:**

Emerson Process Management Limited  
Fosse House, 6 Smith Way  
Grover Park, Enderby  
Leicester LE19 1SX UK  
T +44 0 870 240 1987

**Europe:**

Emerson S.R.L  
Regulatory Compliance Shared Services  
Department  
Company No. J12/88/2006  
Emerson 4 Street  
Parcul Industrial Tetarom 11  
Romania  
T +40 374 132 000

**Middle East/Africa:**

Emerson Energy and Transportation  
Solutions  
Emerson FZE  
P.O. Box 17033  
Jebel Ali Free Zone – South 2  
Dubai U.A.E.  
T +971 4 8118100 | F +971 4 8865465

**Asia-Pacific:**

Emerson Energy and Transportation  
Solutions  
1 Pandan Crescent  
Singapore 128461  
T +65 6777 8211 | F +65 6777 0947

© 2001–2023 Bristol Inc. All rights reserved.

This publication is for informational purposes only. While every effort has been made to ensure accuracy, this publication shall not be read to include any warranty or guarantee, express or implied, including as regards the products or services described or their use or applicability. Bristol Inc. (hereinafter “Energy and Transportation Solutions” or ETS) reserves the right to modify or improve the designs or specifications of its products at any time without notice. All sales are governed by ETS terms and conditions which are available upon request. ETS accepts no responsibility for proper selection, use or maintenance of any product, which remains solely with the purchaser and/or end-user. Emerson and the Emerson logo are trademarks and service marks of Emerson Electric Co. All other marks are the property of their respective owners.