

Type CRONOS

CRONOS Series of “Top-Entry” Pilot-Operated Regulators, Meets a Wide Range of Applications, Offering Tri-Function, Easy Maintenance and Compact Size



C Regulator



CB Regulator + Shut-off



CC Regulator + Monitor



CCB Regulator + Monitor + Shut-off

Benefits:

- Horizontal or 90° Gas Flow Installations
- Tri-Function: Regulator - Monitor - Shut-off
- Counterbalanced Shutter
- Easy Maintenance
- Compact Size
- High Accuracy

Versatile design for highly compact regulating stations

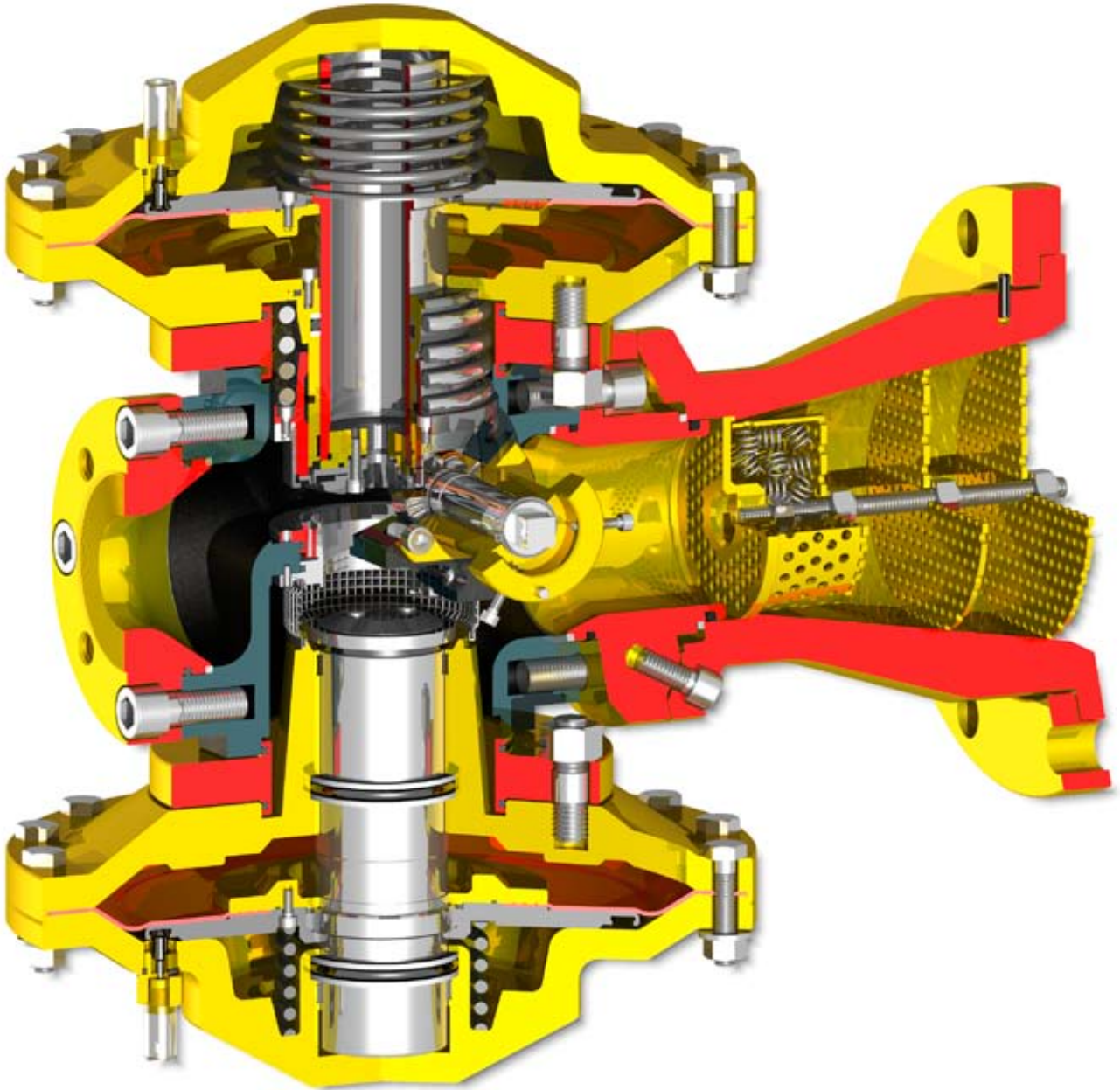

CRONOS Silenced Version Type CCB-SRS

Specifications

PN 25/40 - ANSI 300/600

- Allowable pressure: up to 100 bar
- Inlet pressure range: 1 to 100 bar
- Set range: 0.5 to 80 bar

PN 16 - ANSI 150

- Allowable pressure: up to 20 bar
- Inlet pressure range: 0.2 to 20 bar
- Set range: 0.01 to 8 bar
- Sizes: 1" - 2" - 3"
- Flange Rating:
PN 16, 25, 40 UNI/DIN - ANSI 300, 600

For more information contact:

Italy

Tel.: +39 - 0514190611

Fax: +39 - 0514190715

France

Tel.: +33 (0)2 37 33 47 00

Fax: +33 (0)2 37 31 46 56

email: pressure.regulators@emersonprocess.com