

April 1981

Type N550 Packing Removal/Replacement



WARNING

Only qualified servicemen should attempt to repair these valves. The skill required is similar to the complexity involved in pump repair.

Before starting any type of repair, close off the upstream valves and remove all gas pressure from both the outlet and inlet sides of the Type N550 emergency shutoff valve (ESV).

Before Removing Packing

If the Type N550's operating handle closes slowly or binds in a "no flow" condition, it could be from binding in the packing gland area or from external binding, such as a bent operating handle catching on the latch block, etc. Check for some type of external binding first.

If the binding appears to be internal, it could be from uneven or over-tightened gland bolts (key 33), refer to Figures 1 and 24. Try loosening these two bolts one-half turn each, and tap the shaft (key 15) lightly side to side to align the gland and follower bearing. Snug the bolts down evenly, only tight enough to prevent leakage. If this does not free the handle, the packing must be removed and be either cleaned or replaced.

Removal of Packing

Refer to Figure 24.

Note

If there is leakage around the shaft (key 15), the packing should be replaced. Order parts kit T13090 which includes a

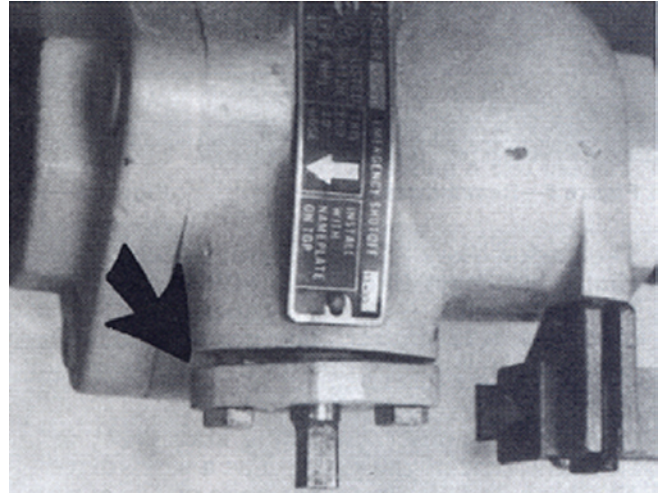

Figure 1. Uneven gland bolts could cause binding

graphite packing adaptor (black), a TFE packing ring (white), a TFE male adaptor (white), a gasket, and two washers (key nos. 26, 29, & 30). With no leakage, only binding, the packing probably can be reused, and the only replacement parts required are the gasket (key 26) and washer (key 29). In either case, use Magnalube G grease (part no. T13049, 1/2 oz. tube which will lubricate many valves) of the regulator.



CAUTION

Throughout the entire removal and replacement procedure, be sure that the shaft (key 15) is not pulled out of the internal lever holding the poppet assembly. If the shaft is pulled out, the



Type N550

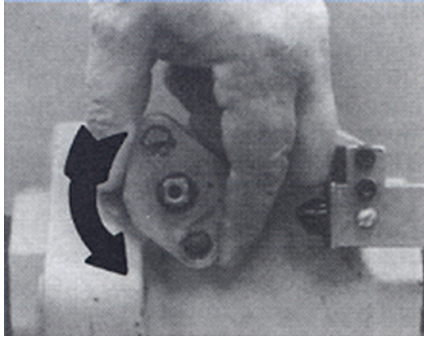

Figure 2. Turn gland retainer (step 3)

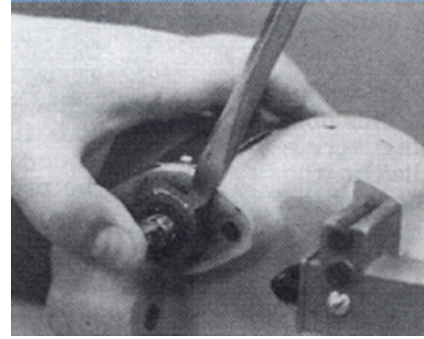

Figure 3. Pry out gland (step 5)



Figure 4. Remove gland (step 6)

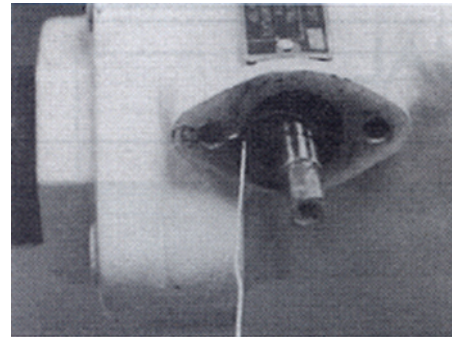

Figure 5. Remove gasket (step 7)



Figure 6. Remove packing carefully (step 8)



Figure 7. Remove packing carefully (step 8)

N550 will have to be removed from the line in order to properly reassemble it. Holding the shaft in place permits the valve to be left in-line if all line pressure is removed.

1. Remove the operating handle (key 18), fuse link assembly (key 22), and retainer (key 24) by unscrewing the bolt (key 23).
2. Take out the two gland bolts (key 33).
3. Turn the gland retainer (key 32) one-half turn counterclockwise, refer to Figure 2.

4. Remove the gland retainer from the gland (key 27).
5. Holding the valve's shaft firmly in place, pry out the gland with a screwdriver, Figure 3.
6. Still holding the shaft in place, work the gland over the end of shaft to remove the gland, Figure 4.
7. The gasket (key 26) may be on the end of the gland, but most likely it is still in the body. Use a stiff wire (such as a paper clip), Figure 5 to remove the gasket. The gasket should be discarded and a new one used when reassembling.
8. Carefully remove the packing stack (key 30) from the rear of the gland. Use a screwdriver, Figure 6, to push between the coils of the spring (key 28) to avoid cutting the packing or scratching the gland.
9. The part shown in Figure 7 will be removed from the gland: follower bearing (key 31), packing stack

(key 30), includes graphite female adaptor, two TFE packing rings, and a TFE male adaptor), a washer (key 29), and the packing spring (key 28).

10. Clean the packing (if it is to be reused), the gland, and the shaft of dirt, grease, and paint.



CAUTION

Paint on the shaft may damage the packing.

Reassembly of Packing



Figure 8. Replacement parts for gland

Refer to Figure 25.

Note

The parts shown in Figure 8 are to be replaced in the gland: packing spring (key 28), two washers (key 29), packing stack (key 30) includes graphite female adaptor one TFE packing ring, and a TFE male adaptor), and the follower bearing (key 31).

1. Install a new gasket (key 26) on the step at the back of the gland (key 27). Note the small hole on the back of the gland, Figure 9. This hole must engage the end of the closing spring (key 25) when the gland is installed in the body. Look in the body and note the position of the end of the closing spring, Figure 10.

2. Insert the gland into the body, and slowly turn the gland while pushing it into place. When the closing spring snaps in the gland's hole, the gland fits in the body as deeply as it had originally.

3. Install the packing spring and the two washers into the gland, Figure 11.

4. Lubricate the shaft, gland, packing, and follower bearing with a liberal amount of Magnalube G grease, Figure 12.

5. Replace the male TFE packing adaptor with the **flat side in**, Figure 13, working it over the shaft and into the gland. Be careful not to damage this adaptor. Apply a liberal amount of Magnalube G grease on the face of this adaptor, Figure 14, so that it will be trapped under the next ring.

6. Install one TFE packing ring with the **female side in**, Figure 15, using the same procedure as in step 5. Again apply a liberal layer of Magnalube G grease.

7. Install the graphite adaptor **flat side out**, Figure 16.

8. Install the follower bearing and press it in place with the gland retainer, Figure 17. The bearing will extend about 1/8-inch (3,2 mm) from the gland, Figure 18.

9. Install the gland retainer over the gland. Turn the retainer about one-quarter turn clockwise Figure 19, then let the spring turn the gland back until it stops.

10. Remove the retainer and fit it back on the gland so that the bolt holes line up as closely as possible with bolt holes in the body, Figure 20.

11. Wind the gland retainer **one-half turn clockwise** and install the bolts (key 33), Figure 21.

Note

Winding the retainer tightens the closing spring. If the spring is wound more than one-half turn, it may bind and pull the end out of the gland when the valve is opened. If not wound enough, the valve may be sluggish on closing.

12. Install the handle assembly (key nos. 18, 22, 23, and 24), Figure 22, and carefully open the valve. If there is binding before the handle goes fully open, the closing spring has been wound too tightly. Repeat steps 9-11 to get the proper spring winding before proceeding.

13. If the handle moves freely to the open position, tap the shaft lightly side to side, Figure 23, to align the follower bearing. The valve should now be ready for service.

14. Carefully repressure the line and check for leaks.

Type N550

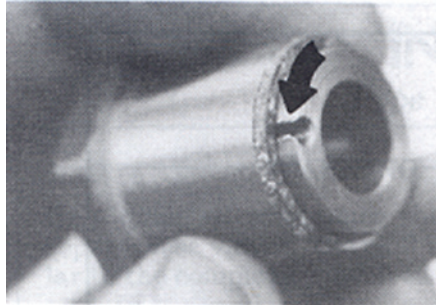

Figure 9. Hole in gland (step 1)

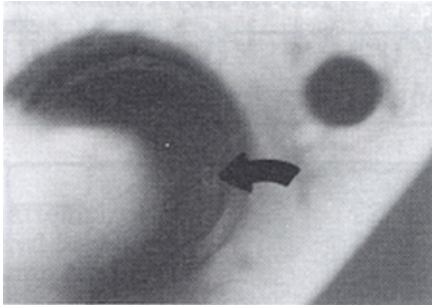

Figure 10. End of closing spring (step 1)

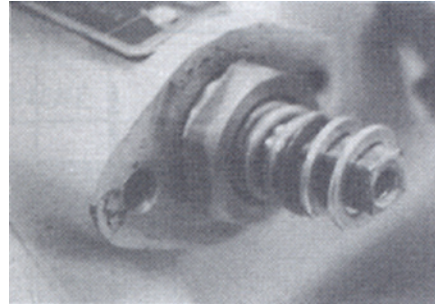

Figure 11. Spring and two washers (step 3)



Figure 12. Lubricate parts (step 4)



Figure 13. Install adaptor (step 5)

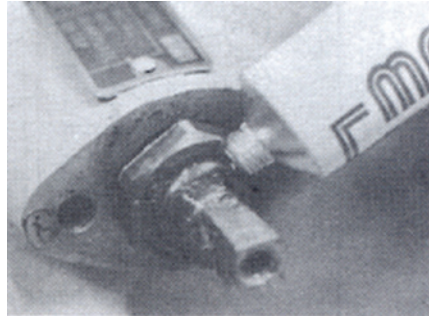

Figure 14. Lubricate (step 5)

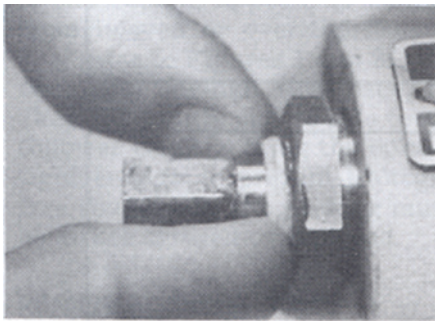

Figure 15. Install packing ring (step 6)

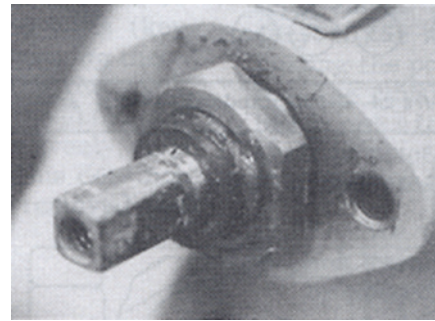

Figure 16. Install graphite adaptor (step 7)

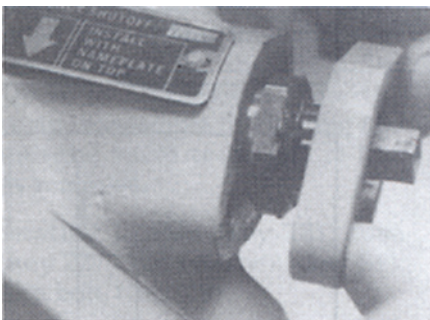

Figure 17. Install follower bearing (step 8)

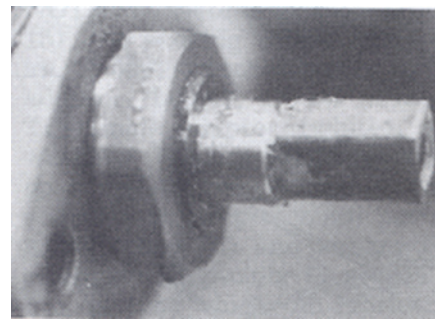

Figure 18. Follower bearing (step 8)

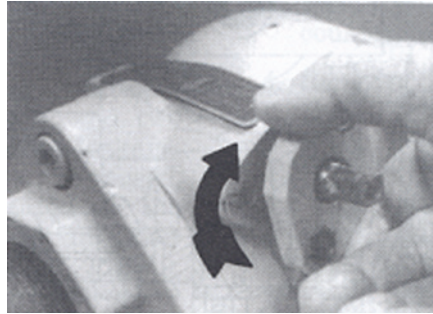

Figure 19. Turn retainer (step 9)

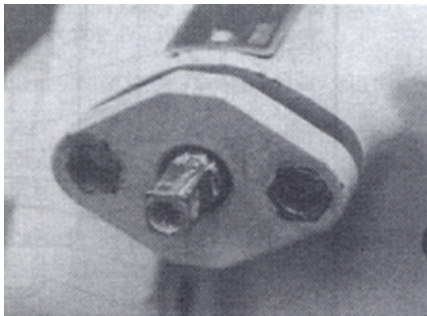

Figure 20. Line up holes (step 10)



Figure 21. Wind retainer, install bolts (step 11)



Figure 22. Install handle (step 12)

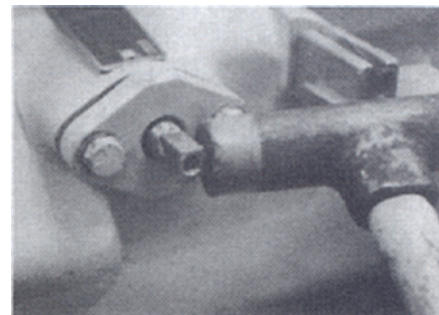

Figure 23. Align parts (step 13)

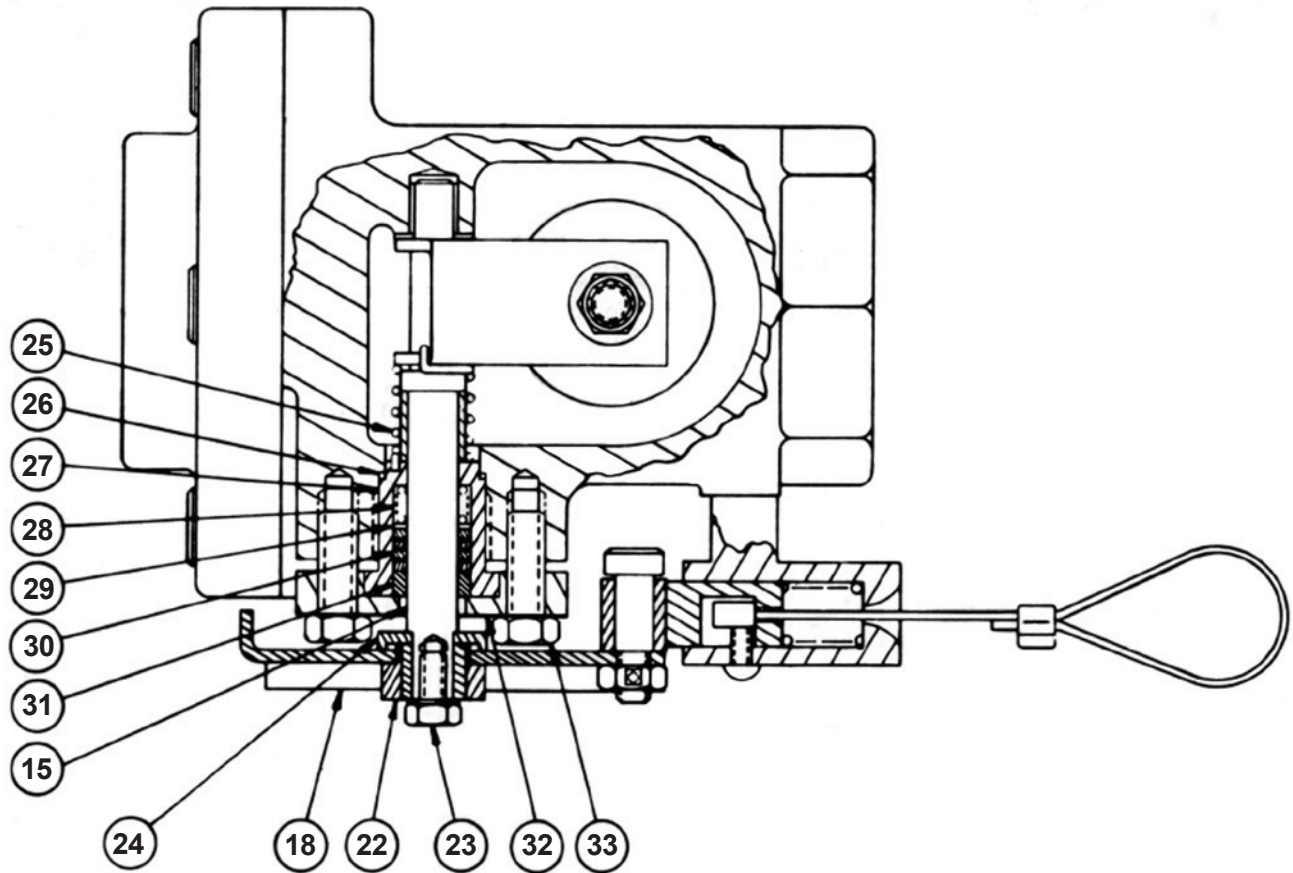

Figure 24. N550 standard packing assembly

Type N550

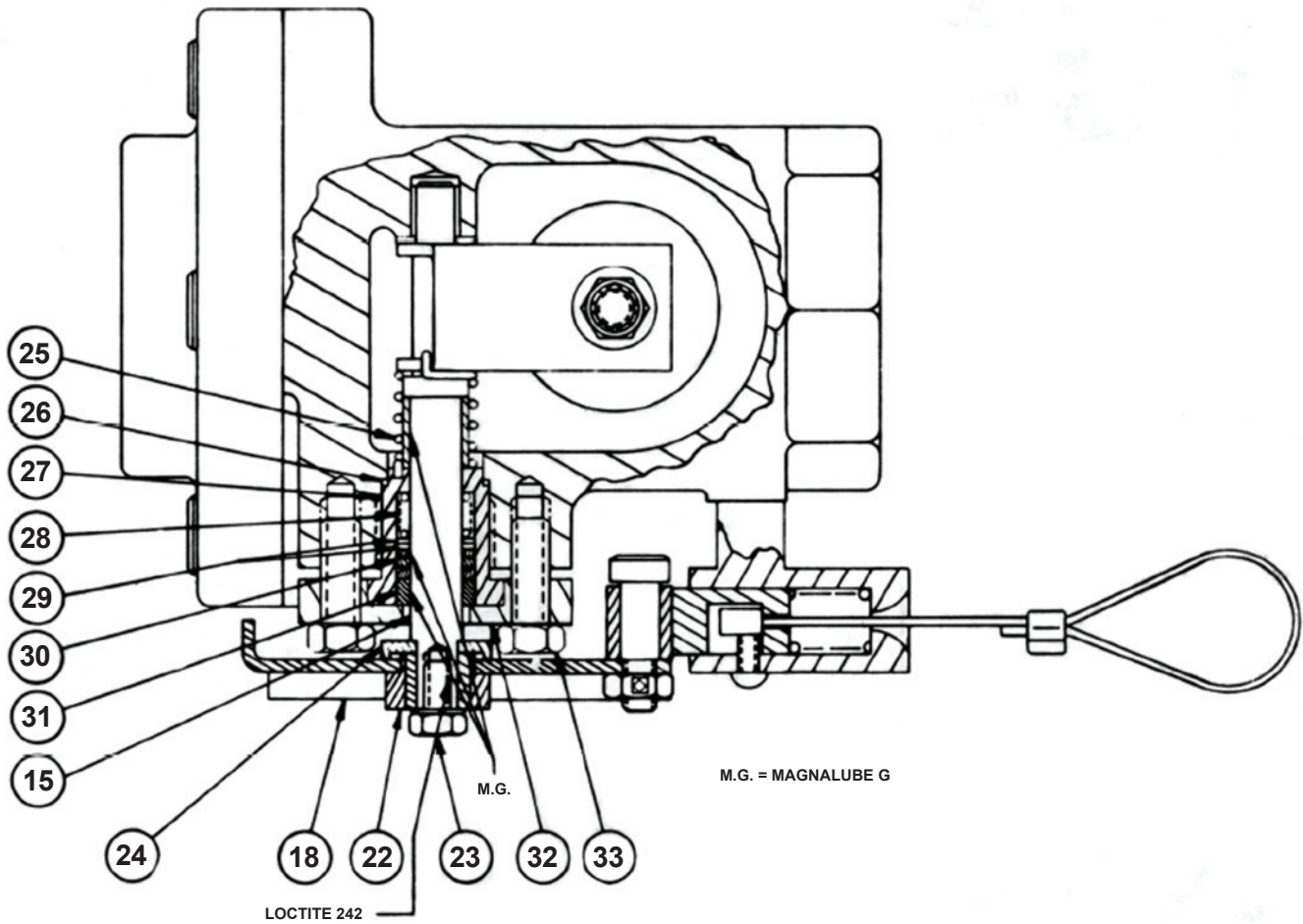

Figure 25. N550 replacement packing assembly

Parts List

Key	Description	Key	Description
15	Shaft	27	Gland
18	Handle Assembly	28	Packing Spring
22	Fuse Link assembly	29	Washer
23	Bolt	30	Packing Stack
24	Retainer	31	Follower Bearing
25	Closing Spring	32	Gland Retainer
26	Gasket	33	Bolt (2 required)

Fisher and Fisher Regulators are marks owned by Fisher Controls International, LLC. The Emerson logo is a trademark and service mark of Emerson Electric Co. All other marks are the property of their respective owners.

The contents of this publication are presented for informational purposes only, and while every effort has been made to ensure their accuracy, they are not to be construed as warranties or guarantees, expressed or implied, regarding the products or services described herein or their use or applicability. We reserve the right to modify or improve the designs or specifications of such products at any time without notice.

Fisher does not assume responsibility for the selection, use or maintenance of any product. Responsibility for proper selection, use and maintenance of any Fisher product remains solely with the purchaser.

Emerson Process Management

Fisher Controls International, LLC.
P.O. Box 8004
McKinney, Texas 75070, USA
Telephone: 1 (800) 588-5853
Telephone: 1 (469) 293-4201